

INSTRUCTION MANUAL
REGULATED DC POWER SUPPLY
PAD-L, TYPE II

APPLICABLE MODELS

PAD 8-50L

PAD 16-50L

PAD 20-40L

PAD 35-30L

PAD 55-20L

PAD 70-15L

PAD110-10L

PAD160-7L

PAD250-4.5L

KIKUSUI ELECTRONICS CORPORATION

M-94091

8035509

194.9
6.66

Power Requirements of this Product

Power requirements of this product have been changed and the relevant sections of the Operation Manual should be revised accordingly.

(Revision should be applied to items indicated by a check mark)

Input voltage

The input voltage of this product is _____ VAC,
and the voltage range is _____ to _____ VAC. Use the product within this range only.

Input fuse

The rating of this product's input fuse is _____ A, _____ VAC, and _____.

WARNING

- To avoid electrical shock, always disconnect the AC power cable or turn off the switch on the switchboard before attempting to check or replace the fuse.
- Use a fuse element having a shape, rating, and characteristics suitable for this product. The use of a fuse with a different rating or one that short circuits the fuse holder may result in fire, electric shock, or irreparable damage.

AC power cable

The product is provided with AC power cables described below. If the cable has no power plug, attach a power plug or crimp-style terminals to the cable in accordance with the wire colors specified in the drawing.

WARNING

- The attachment of a power plug or crimp-style terminals must be carried out by qualified personnel.

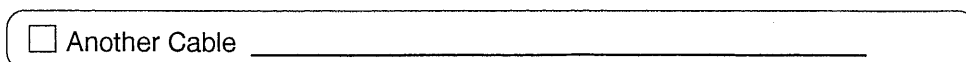
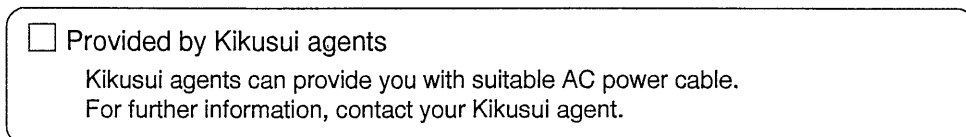
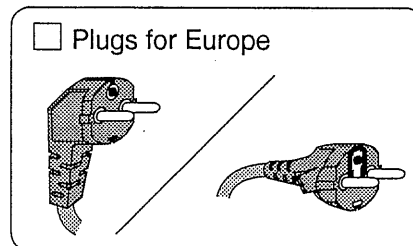
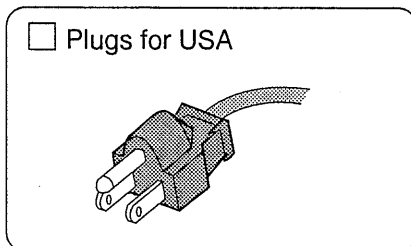
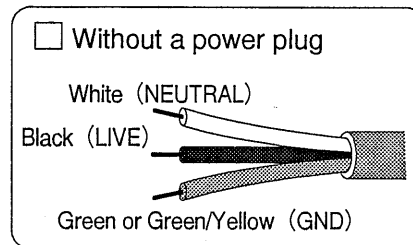
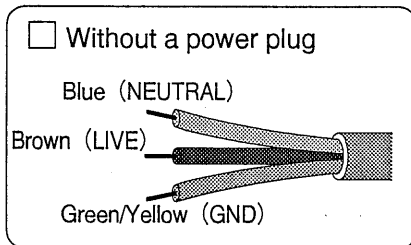

PAD-L シリーズのパネル表示ランプについて Indicator lamps on the panel for PAD-L series

パネルのランプは生産中止となり変更いたしました。
お客様でのランプの交換はできなくなりましたので、予備のランプは付属していません。
切れた場合はお買い上げ元、または当社営業所へお問い合わせください。

Lamps on the panel were dropped from production and changed.
Because it was not possible to replace the lamp with new one by a user, spare lamps are not included.
When the lamp ran out, please inquire to Kikusui distributor/agent.

Copyright© 2000 KIKUSUI ELECTRONICS CORP.
IA002481

PAD-L シリーズのパネル表示ランプについて Indicator lamps on the panel for PAD-L series

パネルのランプは生産中止となり変更いたしました。
お客様でのランプの交換はできなくなりましたので、予備のランプは付属していません。
切れた場合はお買い上げ元、または当社営業所へお問い合わせください。

Lamps on the panel were dropped from production and changed.
Because it was not possible to replace the lamp with new one by a user, spare lamps are not included.
When the lamp ran out, please inquire to Kikusui distributor/agent.

Copyright© 2000 KIKUSUI ELECTRONICS CORP.
IA002481

TABLE OF CONTENTS

	<u>PAGE</u>
SECTION 1. GENERAL	1
1-1. Description	1
1-2. Specifications	3
* Power Consumption Chart	5
* Mechanical Outline Drawing	8
SECTION 2. OPERATION	9
2-1. Precaution for Operation (Installation)	9
2-2. AC Input Requirements (100V, 200V)	13
* Front and Rear Panel	15
2-3. Explanation of Front and Rear	16
2-4. Constant-voltage Operation	19
2-5. Constant-current Operation	20
SECTION 3. PROTECTORS	22
3-1. Description	22
3-2. Explanation of Protective Circuit	23
3-3. Operation Method of Overvoltage Protector (OVP)	24
SECTION 4. APPLICATIONS	26
4-1. Remote Sensing	26
4-2. Output-voltage Control with an External Voltage or Resistance	27
4-3. On-off Control of Output	32
4-4. Output-current Control with an External Voltage or Resistance	33
4-5. One-control Parallel Operation	36
4-6. One-control Series Operation	38
4-7. Constant-current Charge/Discharge of Battery or Capacitor	41
4-8. Remote Turning Off of The Power Switch	43

82.5.20
803551A

	<u>PAGE</u>
SECTION 5. THEORY OF OPERATION	44
5-1. Description of Preregulation Circuit	44
5-2. Controlled Rectifier Circuit and Filter Circuit	46
5-3. Phase Control Circuit	47
5-4. Constant-voltage Circuit	48
5-5. Constant-current Circuit	50
5-6. Differences from Ideal Power Supply	52
* Block diagram	55
SECTION 6. MAINTENANCE	56
6-1. Inspection and Adjustment	56
6-2. Troubleshooting	61

80352A

SECTION 1. GENERAL

1-1. Description

The PAD-L Power supply is designed for high operation reliability and excellent electrical performance. It is a universal-purpose industrial power supply which can be used as a variable power source for research and development, or as a fixed power source for long time aging test. Features of the PAD-L Power Supply can be summarized as follows:

1. Improved power factor at low output voltage:

A choke input system is used for the rectifier filter circuit, thereby reducing the apparent input current and improving the power factor. This led to a smaller power transformer and consequently to a compact and light power supply.

2. Less waveform distortion caused to the AC input line:

As the choke input system is used, the input current waveform is less distorted with harmonics, thereby reducing waveform distortion to the AC input line.

3. Excellent temperature coefficient:

Very low temperature drift characteristics of 50 ppm/°C is attained by using premium-quality parts, improved circuits, and forced air cooling. Time-elapse drift (aging drift) also is very low.

4. Fast transient response:

A wide-band error amplifier is used to ensure stable frequency - gain, phase characteristics.

5. Low ripple and noise voltages:

Ripple and noise voltages are low, both in rms and peak values.

The output voltage is finely adjustable from 0 V to the rated voltage with a 10-turn potentiometer.

The power supply has a current/voltage limit switch to preset a current/voltage value. The set value of constant-voltage/constant-current operation can be checked when in operation.

The power supply has internal protection such as voltage detector, current detector and temperature detector circuits. An overvoltage protector (OVP), voltage adjustable from the front panel, also is incorporated as a standard feature. A high speed overvoltage protector (a thyristor crowbar protection circuit) is available as an option.

The power supply is housed in a casing for bench top use. It can be installed on a standard 19-inch (500-mm) rack.

The user is requested to read thoroughly this instruction manual before operating the power supply.

- * It is highly recommended to use the thyristor crowbar high-speed overvoltage protector OVP (option) for a load whose allowable voltage range is very narrow and which could be damaged when a slight overvoltage is applied.

803554A

1-2. Specifications

Model	PAD 8-50L	PAD 16-50L	PAD 20-40L	PAD 35-30L	PAD 55-20L	PAD 70-15L	PAD 110-10L	PAD 160-7L	PAD 250-4, 5L
Input	120V/240V ± 10%, 50Hz/60Hz AC, 1 φ								
Input supply	120V/240V ± 10%, 50Hz/60Hz AC, 1 φ								
Power consumption	120V AC	Rated load							
Output	120V/240V ± 10%, 50Hz/60Hz AC, 1 φ								
Output voltage range	0-8V	0-16V	0-20V	0-35V	0-55V	0-70V	0-110V	0-160V	0-250V
Voltage resolution (theoretical value)	1.5mV	3mV	3.6mV	6.3mV	10mV	13mV	20mV	29mV	45mV
Output current range	0-50A	0-50A	0-40A	0-30A	0-20A	0-15A	0-10A	0-7A	0-4.5A
Current resolution (theoretical value)	170mA	170mA	136mA	102mA	68mA	51mA	34mA	24mA	16mA
Constant voltage characteristics									
Regulation	*1								
Source effect (line regulation) (For ±10% change of line voltage)	0.005% + 1mV								
Load effect (load regulation) (For 0 to 100% change of output current)	0.005% + 2mV								
Ripple and noise (5 Hz - 1 MHz) rms	*2								
Transient response (typical)	*3								
Temperature coefficient (typical)	50 ppm/°C								
Remote control resistance and voltage	Approx. 0 - 10kΩ, 0 - 10 V								
Constant current characteristics									
Regulation									
Source effect (line regulation) (For ±10% change of line voltage)	3mA	3mA	3mA	3mA	3mA	3mA	1mA	1mA	1mA
Load effect (load regulation) (For 0 to 100% change of output voltage)	5mA	5mA	5mA	5mA	5mA	5mA	3mA	2mA	2mA
Ripple and noise (5 Hz - 1 MHz) rms	*2								
Remote control resistance/voltage, approx. [kΩ/V]	1/0.5	1/0.5	1/0.4	1/1.0	1/1.0	1/1.0	1/1.0	1/1.1	1/0.45
Operating ambient temperature range	0 - 40°C (32 - 104°F)								
Operating ambient humidity range	10% - 90% RH								
Cooling method	Forced air cooling with fan								
Polarity of output voltage	Positive or negative grounded								
Isolation from ground	±250V DC								
	±500V DC								

Notes: *1. Measured using the sensing terminals.

*2. Measured with the positive or negative output grounded.

*3. Recovery time within 0.05% + 10mV of the output voltage.

Model	PAD 8-50L	PAD 16-50L	PAD 20-40L	PAD 35-30L	PAD 55-20L	PAD 70-15L	PAD 110-10L	PAD 160-7L	PAD 250-4, 5L
Protections									
Operation	Input power switch is turned off.								
Trip temperature of thermal protector	100°C (212°F) at cooling package								
Overvoltage protection (OVP)									
Voltage setting range	*4	3-10V	6-18V	6-22V	6-38V	11-60V	15-80V	20-129V	30-180V
Trigger pulse width	*4	50msec.							
Input fuse rating									
At 120V AC source	15A	30A							
At 240V AC source	10A	15A							
Output fuse rating	50A	50A	40A	30A	20A	15A	10A	10A	5A
Meters									
Voltmeter, Full scale, Class 2.5	8V	16V	20V	35V	60V	70V	110V	175V	250V
Ammeter, Full scale, Class 2.5	60A	60A	40A	35A	22A	15A	12A	8A	5A
Constant voltage mode indication	C.V : With green LED								
Constant current mode indication	C.C : With red LED								
Insulation resistances									
Between chassis and line	500V DC, more than 30MΩ								
Between chassis and output terminal	500V DC, more than 20MΩ								
Dimensions									
Maximum dimensions	430W × 160H × 400D mm (16.9W × 6.3H × 15.8D in.)								
Weight	Approx. 31 kg	Approx. 33 kg	Approx. 33 kg	Approx. 34 kg	Approx. 33 kg	Approx. 34 kg	Approx. 33 kg	Approx. 36 kg	Approx. 34 kg
Accessories (in carton)									
Instruction manual	1 copy								
Input line fuse (spare)									
For 120V AC	15A, 1 ea.	30A, 1 ea.							
For 240V AC	10A, 1 ea.	15A, 1 ea.							
Input cord	3-core cabtire cord 1								
Others	Voltage check chips 2								
	Guard cap 1 set								

Notes: *4. Typical value

*5. With rack mount brackets (option), can be mounted on a standard 19-inch or 500-mm rack.

799808

Power Consumption Chart 100V/200V, 50Hz/60Hz AC

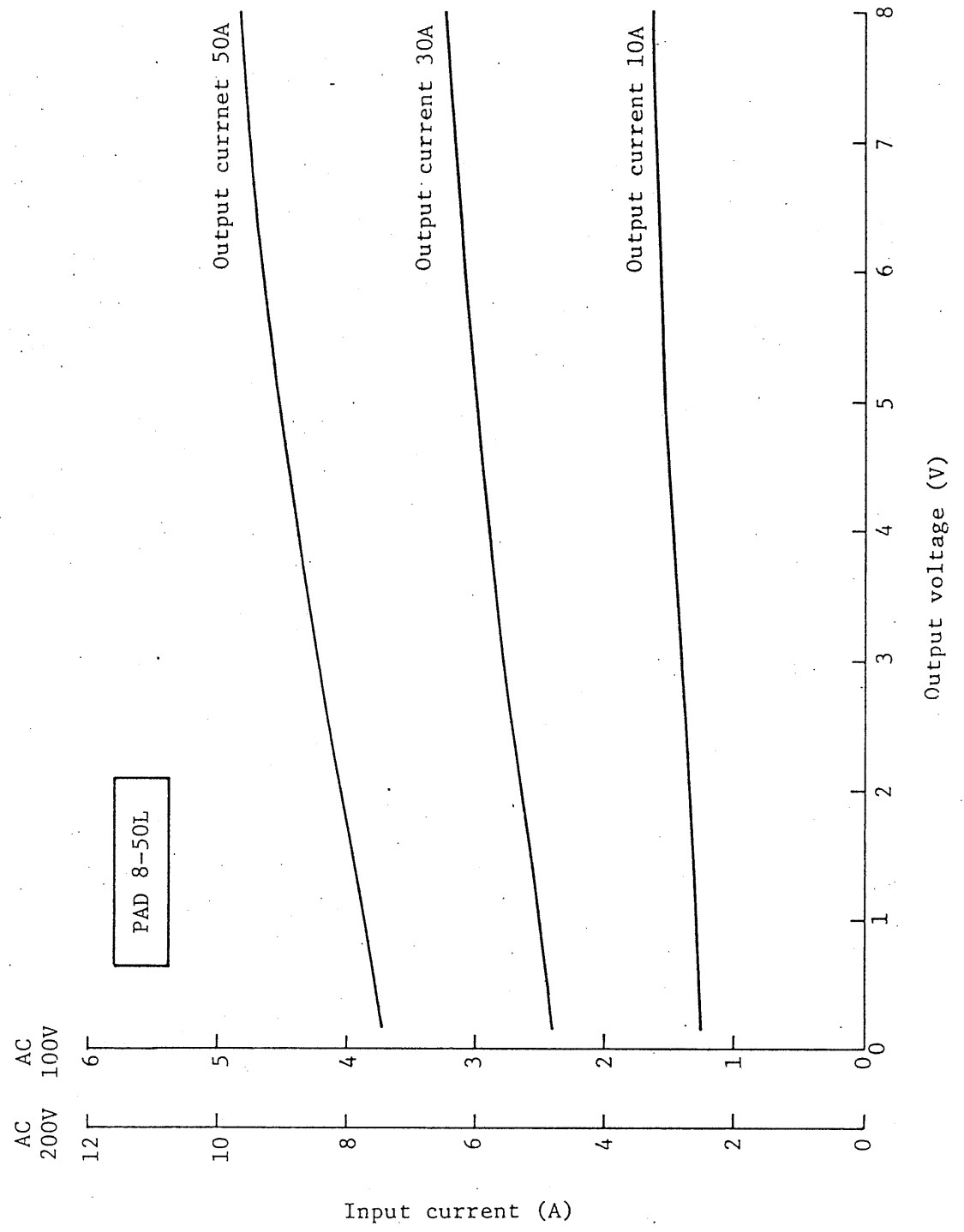

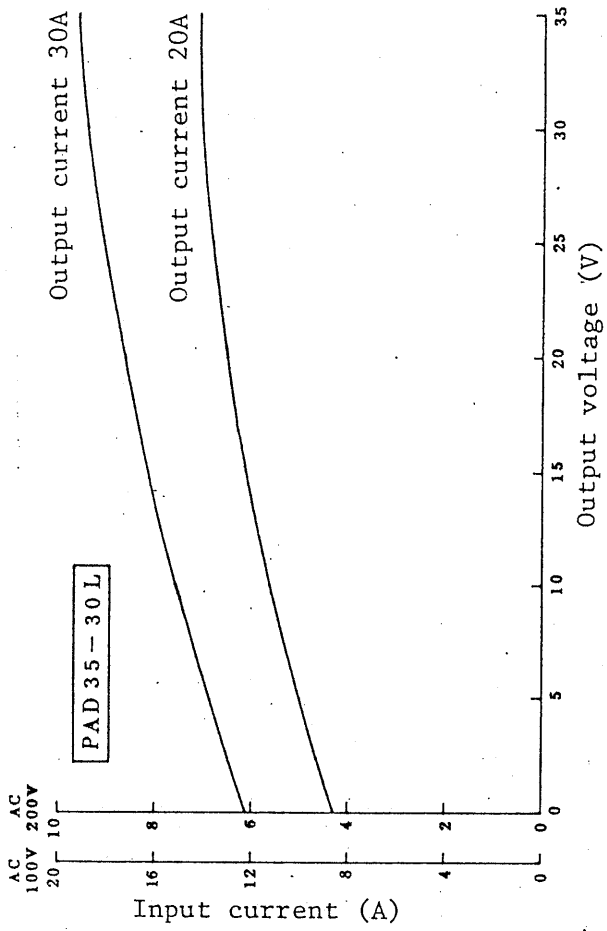
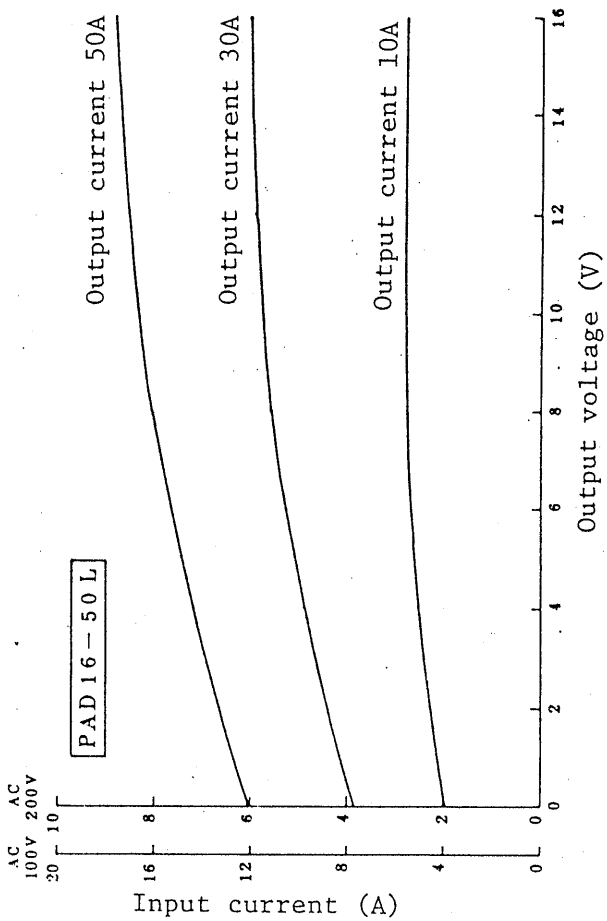

Power Consumption Chart

100V/200V, 50Hz/60Hz AC

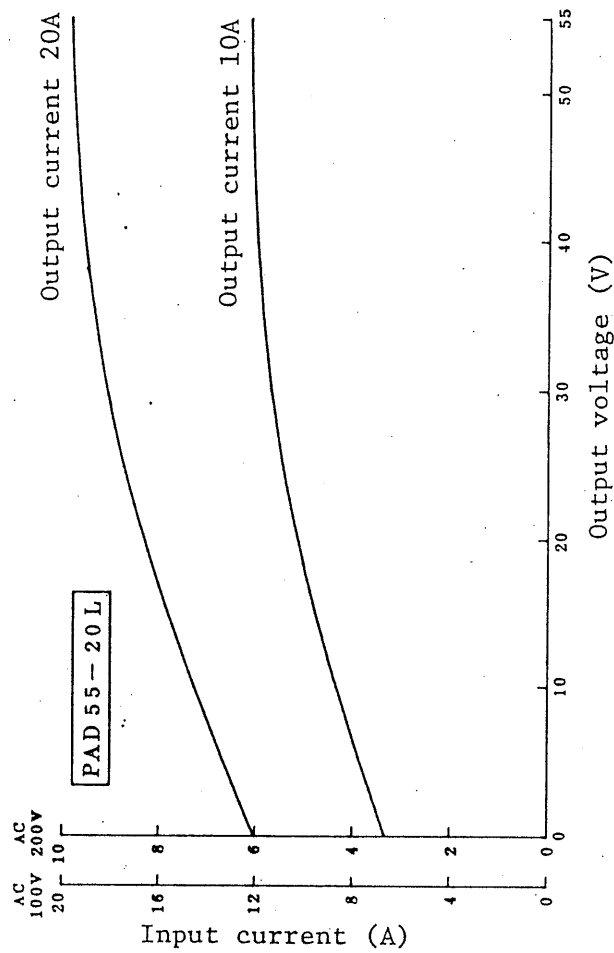
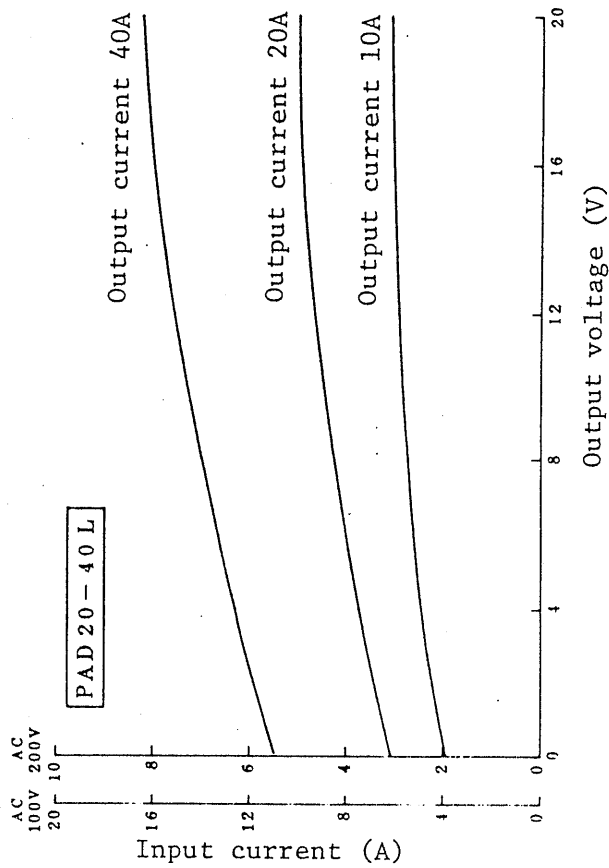

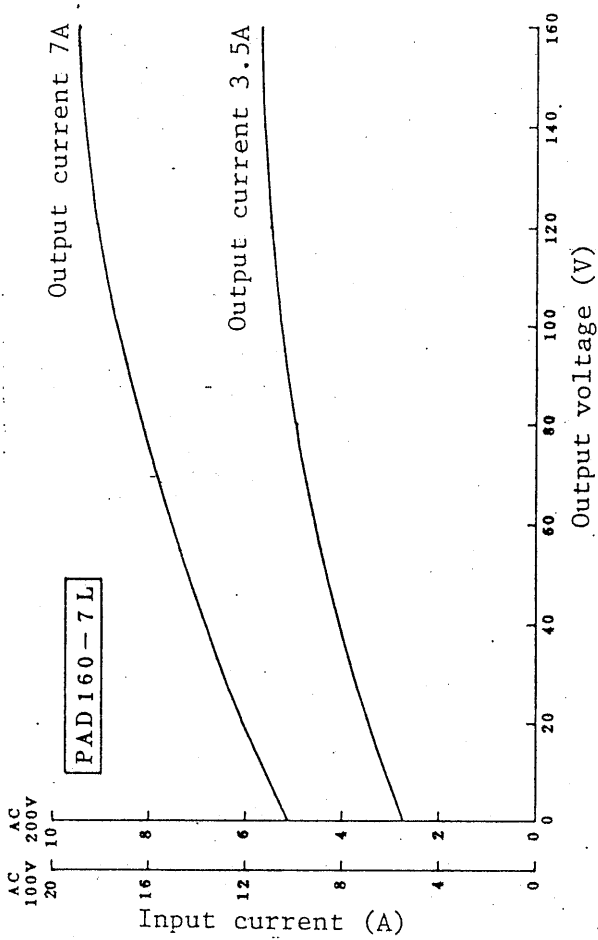
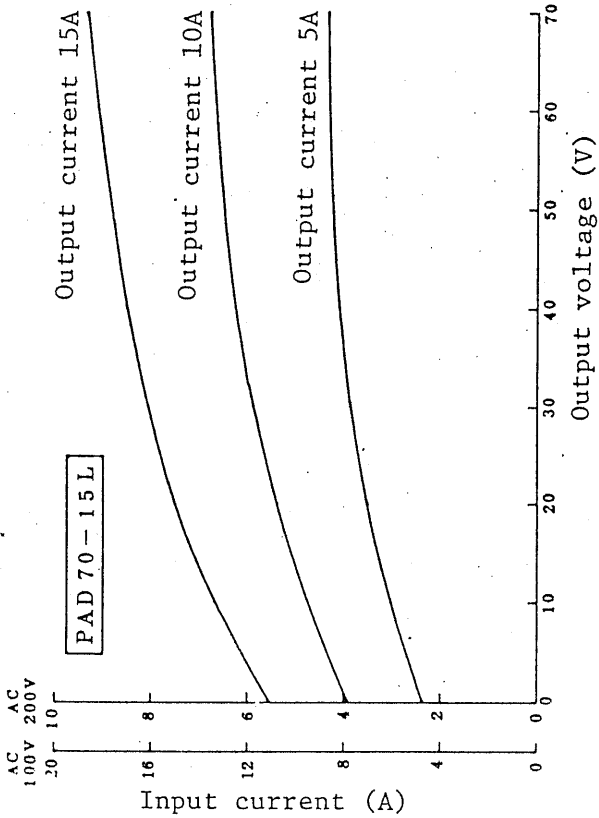

Power Consumption Chart

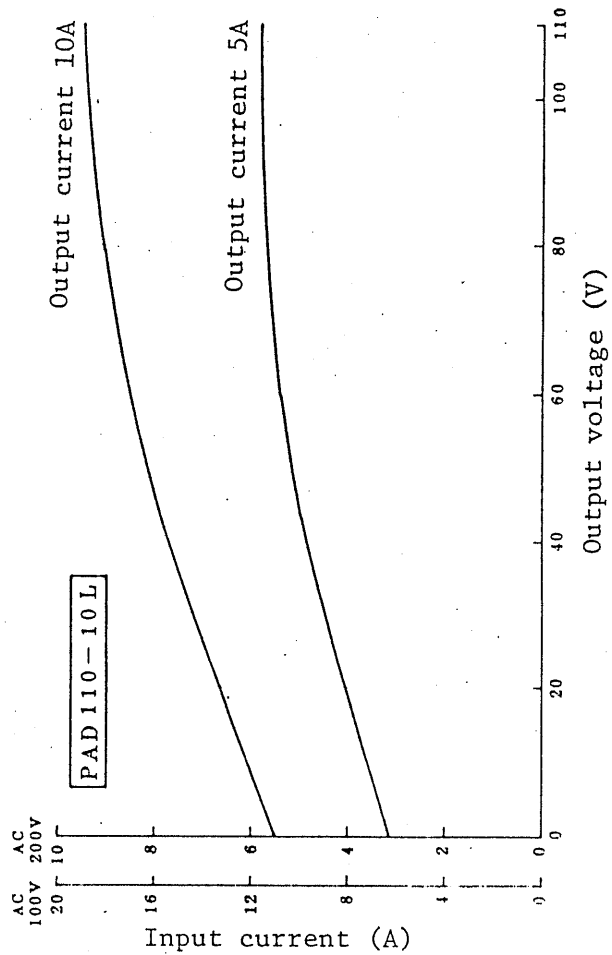

100V/200V, 50Hz/60Hz AC

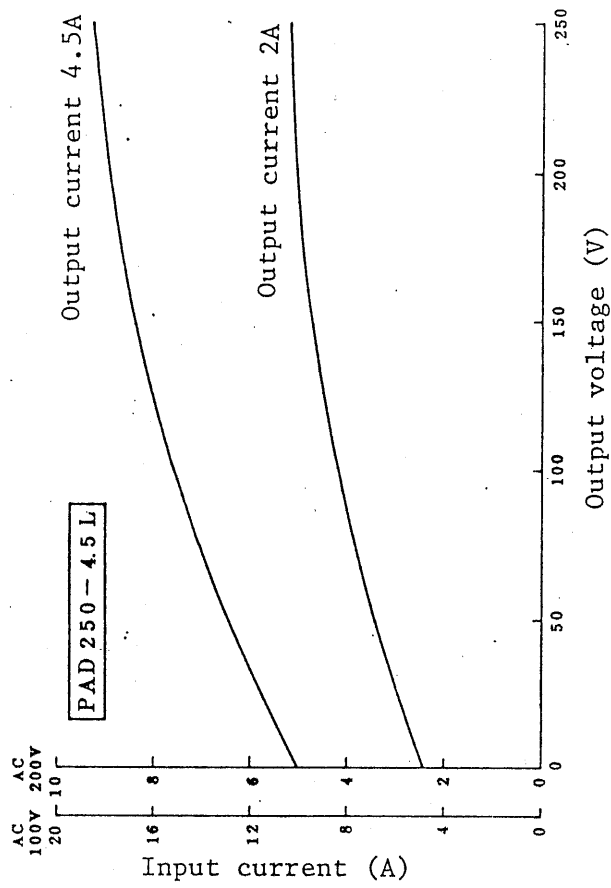

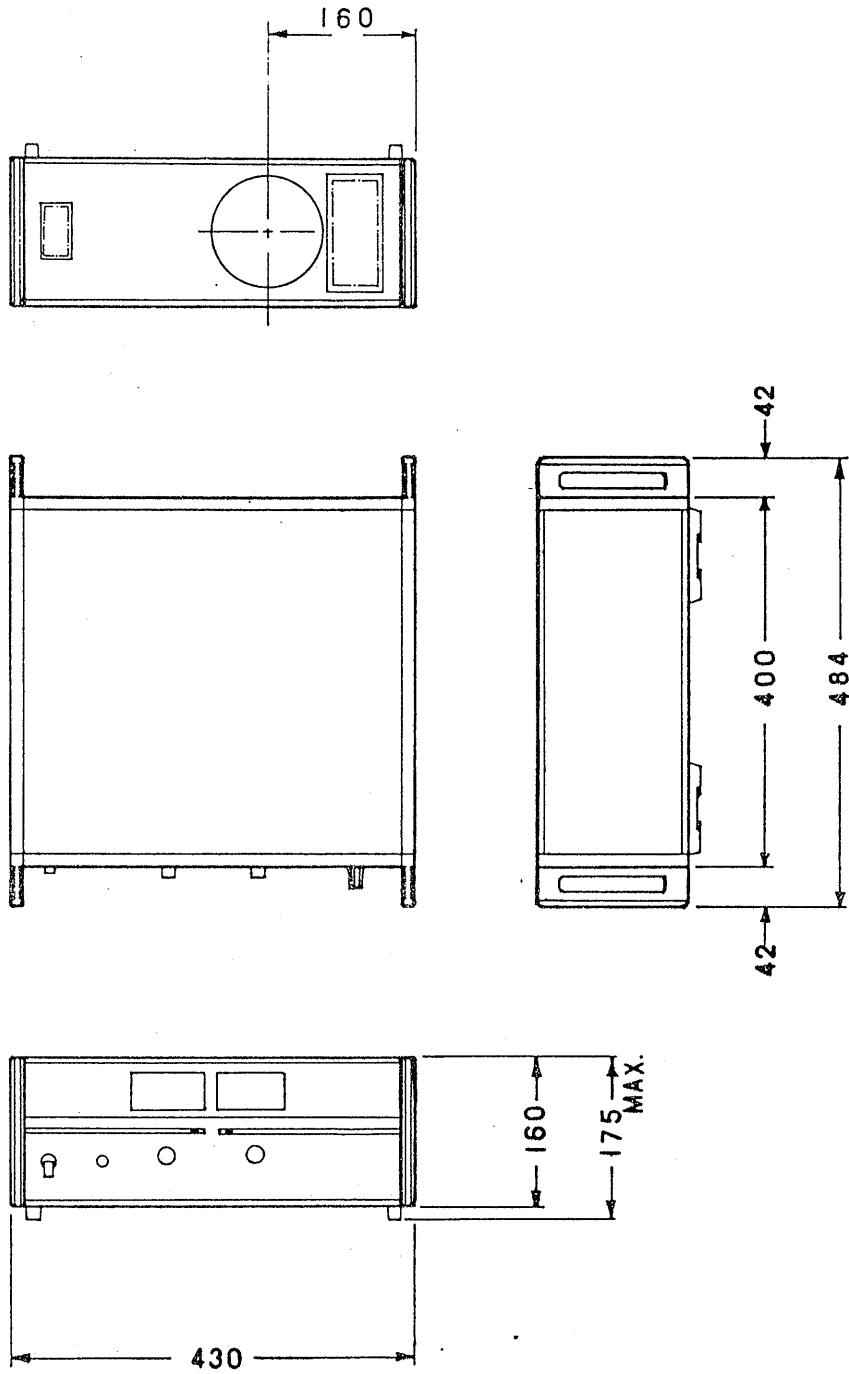

Unit: mm

Figure 1-1. Mechanical Outline Drawing

803560A

SECTION 2. OPERATION

2-1. Precaution for Operation (Installation)

1. Input power

- o The input voltage range is 108 - 132 V (216 - 264 V),
48 - 62 Hz single-phase AC.
- o The input power fuse rating is
30A for 120 V (15A for PAD8-50L)
*15A for 240 V (10A for PAD8-50L).
- o For current consumption, see the power consumption charts.

2. Power cord

- o A power cord (cable) of core wires of 3.5 mm²
accompanies the power supply. (2 mm² for PAD8-50L)
- o Securely connect the core wires with crimping terminals or
other appropriate method.
- o The green wire is for ground. Be sure to connect this wire
to a good earth ground for safety.

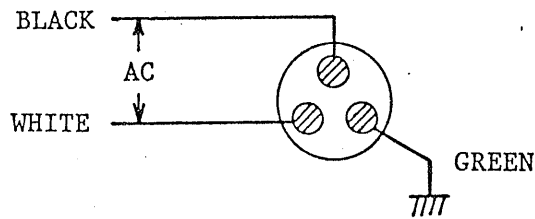

Figure 2-1. Cross section of cable

3. Output

- o Make sure that the jumpers of the terminal blocks on the
rear panel are securely connected as shown in Figure 2-2.

803561A

- o The output power is available either at the front panel (binding post terminals) or at the rear panel (terminal blocks). (* Of Models PAD8-50L, PAD16-50L and PAD20-40L, the output power is available only at the rear panel.)

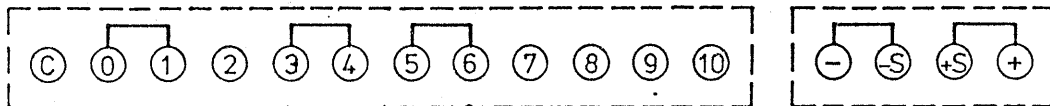

Figure 2-2

- o Normally, connect either one of the output terminals to the GND terminal with the shorting bar.
 - o For connecting the output to a load, use wires of a sufficient current rating referring to Table 2-1. If wires of an insufficient current rating is used, the voltage at the load may become unstable due to voltage drop in the wires, or the wires may be overheated in an extreme case.
4. Ambient temperature
- o The ambient temperature range for the power supply to satisfy the specification performances is 0°C to 40°C (32°F to 104°F). The power supply should be used within this range. If it is operated at a high ambient temperature, the internal temperature detector circuit trips and the input power switch is turned off. If this has happened, cool it and then turn on the power again. There is an exponential relationship between ambient temperature and semiconductor life, electrolytic capacitor life and transformer insulation life. Note that components are rapidly deteriorated at high temperatures. It is important not to operate the power supply at an abnormally high ambient temperature also from the viewpoint of its life.

803562A

- o If the power supply is used at a temperature lower than -10°C , its operation may become unstable. If the power supply is to be used at low temperatures, specify so when ordering.

5. Place for use

- o Pay attention so that the ventilation ports (top and bottom) and the fan air outlet are not blocked.
- o Hot air comes out of the fan air outlet. Do not place near the outlet an object which is not heat resistant.
- o Do not use the power supply in a highly humid or dusty place as such can cause failures.
- o Select a place where is reasonably free from vibration.
- o Do not place a high sensitivity instrument on or near the power supply which produces a strong electric and magnetic fields.

6. Note for carrying

- o The center of gravity of the power supply is at a forward position. Be careful when raising the power supply without using the handles.

7. Note for load

Note that the output may become unstable depending on characteristics of loads as follows:

- (a) When the meter reading (average value) is less than the preset value, if the current has peaks which exceed the preset value, the operation is driven into the constant current domain for the short periods of time and the output voltage falls. Observing carefully, it can be seen that the constant-current indicator lamp becomes dim.

8035637A

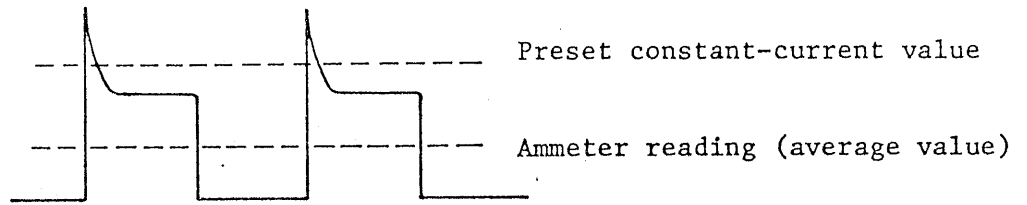

Figure 2-3. Load current with peaks

In this case, raise the preset value or increase the current rating.

- (b) When a regenerative load (such as inverter, converter, or transformer) is connected to the power supply, as it cannot absorb the reverse current fed from the load, the output voltage increases and becomes unstable. In such a case, connect a bypass resistor (R) in parallel with the load and feed in this resistor a current larger than the maximum reverse current.

$$R [\Omega] \leq \frac{E_0 [V]}{I_{RP} [A]}$$

where, E_0 : Output voltage

I_{RP} : Maximum reverse current

8. Fixed or Semi-fixed Output

When a guard cap (accessory) used, the potentiometer is fixed or semi-fixed as shown under.

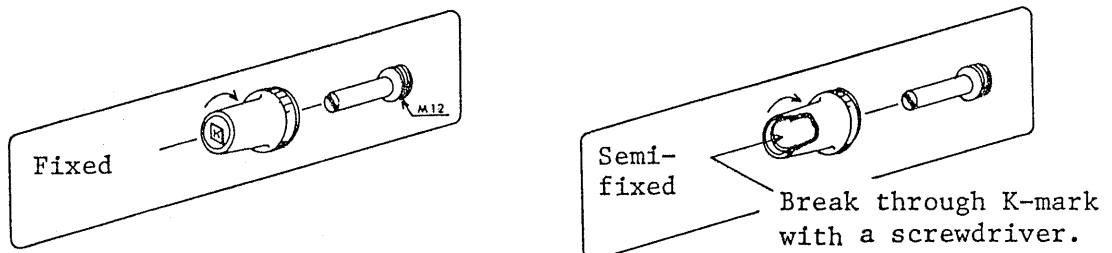

Figure 2-4

803564A

Table 2-1. Wire gauges and current ratings

Ta=30°C (86°F)

Nominal cross section	Maximum current recommended by Kikusui	Maximum current designated by Electrical Installation Technical Ordinance (Article 29). JAPAN
2 mm ²	10 A	27 A
5.5 mm ²	20 A	49 A
8 mm ²	30 A	61 A
14 mm ²	50 A	88 A
22 mm ²	80 A	115 A
30 mm ²		139 A
38 mm ²	100 A	162 A
50 mm ²		190 A
60 mm ²		217 A
80 mm ²	200 A	257 A
100 mm ²		298 A
125 mm ²		344 A
150 mm ²	300 A	395 A
200 mm ²		469 A

2-2. AC Input Requirements (100V, 200V)

The power supply can be converted for operation on a 120 V (±10%) line or a 240 V line by changing internal terminal board connections.

1. Change connections on terminal board of main power transformer. (See Figure 2-4.)

2. Change input power fuse.

For 120 V AC 30 A (15A for PAD8-50L)

For 240 V AC 15 A (10A for PAD8-50L)

3. Change input voltage markplate. (See Figure 2-5.)

D03565A

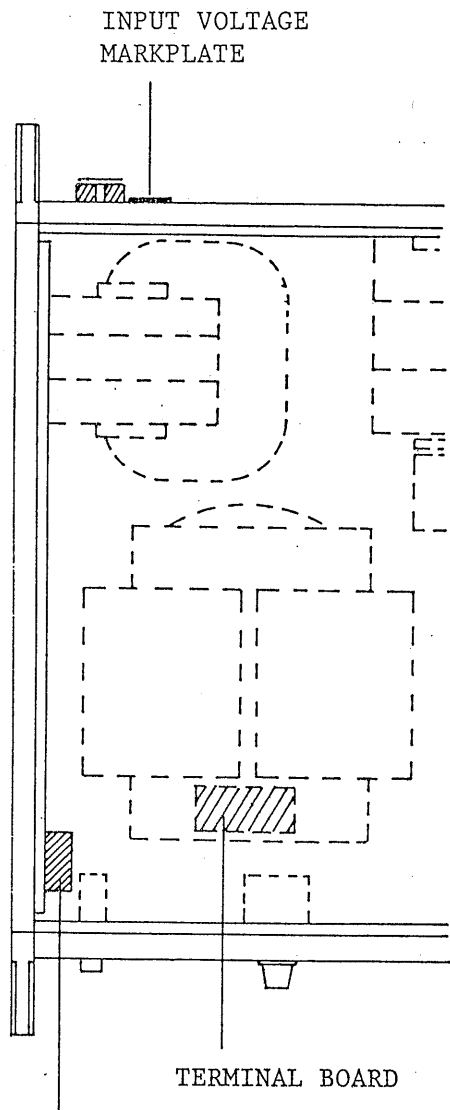

INPUT FUSE

(PAD8-50L is different.
See Figure 6-1, page 60.)

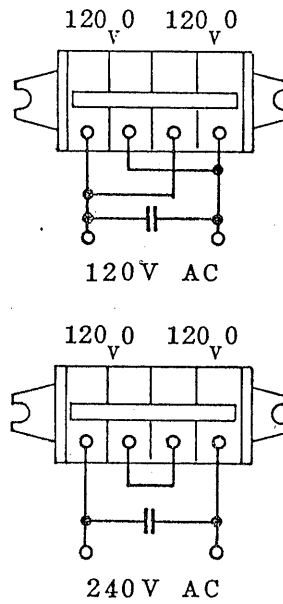

For 120V AC

For 240V AC

Figure 2-5

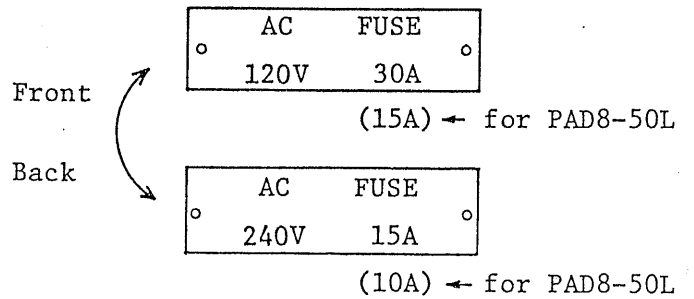

Figure 2-6

8035661A

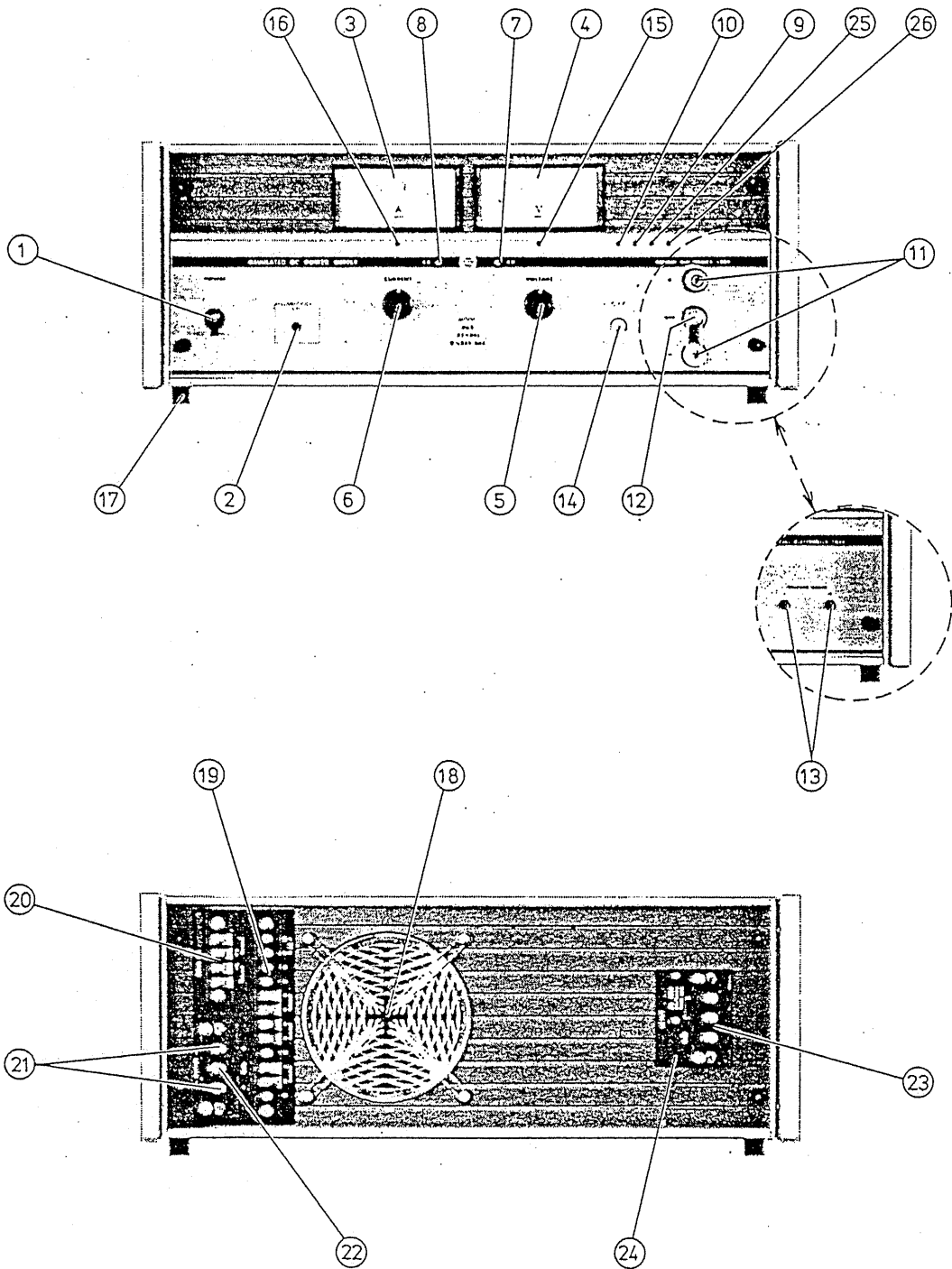

Figure 2-7. Front and Rear Panel

88.8.26

803561B

2-3. Explanation of Front and Rear

Panel items and descriptions

1. POWER switch/Circuit Breaker:

Circuit breaker serves as AC power switch. When thrown to the upper position, the input power is turned on and C.V. or C.C. lamp lights.

Note: The input power is automatically turned off when any one of the internal protectors (over voltage protector, voltage detector, current detector and temperature detector) has tripped. The input power cannot be turned on immediately after it is turned off by the above cause. Eliminate the cause, wait about 60 seconds and then turn on the input power.

2. CURRENT/VOLTAGE LIMIT switch:

Push to set crossover point of CV/CC. The ammeter indicates the preset constant-current value and the voltmeter indicates the preset constant-voltage value.

3. Ammeter:

Monitors output current. Class 2.5

4. Voltmeter:

Monitors output voltage. Class 2.5

5. Voltage setting knob:

Adjusts output voltage for constant-voltage operation.
10-turn potentiometer

(See Fixed or semi-fixed output page 12.)

6. Current setting knob:

Adjusts current for constant-current operation.

1 turn potentiometer

(See Fixed or semi-fixed output page 12.)

7. C.V. (constant-voltage operation indicator lamp):

Energizes in constant-voltage mode. Green LED

8. C.C. (constant-current operation indicator lamp):

Energizes in constant-current mode. Red LED

9. Voltmeter calibration (R101):

For voltmeter calibration. (Periodically calibrate the voltmeter referring to SECTION 6 "MAINTENANCE.")

10. Ammeter calibration (R102):

For ammeter calibration. (Periodically calibrate the ammeter referring to SECTION 6 "MAINTENANCE.")

11. Output terminals:

(PAD8-50L, PAD16-50L and PAD20-40L do not have these output terminals.)

12. GND terminal:

Be sure to connect this terminal to a good earth ground.

(PAD8-50L, PAD16-50L and PAD20-40L do not have this terminal.)

13. VOLTAGE CHECK*

For checking the output voltage from the front panel.

Can be set at the output voltage using the chips supplied.

Fuse (0.1A) is incorporated. (*These voltage check terminals are provided only for PAD8-50L, PAD16-50L and PAD20-40L.)

803569A

14. Overvoltage protector (OVP) (See 3-3 "Operation Method of Overvoltage Protector."):

When the output voltage has exceeded the set value due to inadvertent operation or instrument failure, the input power switch is instantaneously cut off to protect the load.

15. Zero adjustment of voltmeter:

To adjust the voltmeter at 0 V.

16. Zero adjustment of ammeter:

To adjust the ammeter at 0 A.

17. Rubber stud

18. Fan exhaust area:

Air exit of the cooling package. As hot air comes out of this outlet, do not obstruct. The outlet must be positioned 30 cm or over from wall.

19. Terminal block:

Terminals for remote control and series/parallel operation of two or more units.

(See SECTION 4 "APPLICATIONS.")

20. Sensing terminal (sampling terminals):

These terminals are used for remote sensing.

(See SECTION 4 "APPLICATIONS.")

21. Output terminals:

Provide the output power.

803570A

22. GND terminal:

Be sure to connect this terminal to a good earth ground.

23. Input terminals:

The input power for the instrument is connected to these terminals.

24. Input voltage markplate

25. Output voltage offset control (V.os)

For adjustment of output voltage when the voltage setting knob is turned to the counterclockwise extreme position or for adjustment of input offset voltage when in remote control with voltage signal.

26. Output current offset control (I.os)

For adjustment of output current when the current setting knob is turned to the counterclockwise extreme position or for adjustment of input offset voltage when in remote control with voltage signal.

2-4. Constant-voltage Operation

Check first that the AC line voltage is 120V (240V) $\pm 10\%$ AC.

Then, proceed as follows:

- (1) Turn the current setting knob to the extremely counterclockwise position.
- (2) Turn on the input power switch. The C.C. lamp (red LED) will light indicating that the instrument power is on.
- (3) Keeping depressed the current/voltage limit switch, set the output voltage at the required value with the voltage setting knob. By this procedure, setting of the output voltage is complete. (At this stage, the output power is not delivered to the output terminals yet.)

88.8.26

8035715

- (4) Gradually turn clockwise the current setting knob to the point where the C.V. lamp (green) lights and the output power is delivered to the output terminals.

Setting of current limit

- (5) Keeping depressed the current/voltage limit switch, set the required constant current value with the current setting knob. Once this setting is done, no output current larger than the set value flows even when the load is rapidly changed. (The load is protected by automatically changing the instrument operation from the constant-voltage mode to the constant-current mode. This function is called "crossover".)

- Notes: 1. Pay attention when setting the O.V.P. voltage. At the instant the O.V.P. circuit operates, the input power switch is cut off. Set the O.V.P. voltage with an allowance of approximately 10%.
2. When the load resistance is unpredictable or it is predicted to vary largely or when it has a large inductance and rapid voltage application is undesirable, gradually increase the output current by turning the current setting knob from the counterclockwise position in the clockwise direction.

2-5. Constant-current Operation

- (1) Make sure that the AC line voltage is 120V (240V) $\pm 10\%$ AC. Then, connect the input power.
- (2) Turn on the input power switch. The C.V. or C.C. lamp will turn on indicating that the power supply is in the operating state.

88.8.26

803572B

- (3) Keeping depressed the current/voltage limit switch, set the current at the required value with the constant-current knob and, at the same time, set the voltage limit value with the constant-voltage knob. Once this setting is done, the load is protected against overvoltage.
- (4) Turn off the input power switch. Connect the load to the output terminals of the power supply and, then, turn on the input power switch.

- Notes:
1. If the load has a large inductance and it is undesirable to apply rapidly a large current, set the current setting knob in the extremely counterclockwise position and, then, turn on the power switch and gradually increase the current.
 2. If the current/voltage limit switch is depressed when in the constant-current mode, the output current is reduced by approximately 2 mA from the preset value. Pay attention if the load is of such nature that this 2 mA change is critical.

803573A

SECTION 3. PROTECTORS

3-1. Description

Regulated DC power supplies are used, as their name indicates, to supply regulated powers to loads of various types of electronic equipment. Demands for regulated DC power supplies have rapidly increased in recent years. As is the case for other types of electronic equipment, these instruments are required to include features of fast response, high reliability, high efficiency, high power factor, compactness, light weight, and economical price. Various types of power supplies are available on the market today. When selecting regulated DC power supplies, in addition to satisfying the required performances, special attention must be paid to some particular requirements which are slightly different from those required by other types of electronic equipment which handle electronic signals.

The above difference comes from the fact that regulated DC power supplies handle "powers." Malfunctioning or erroneous operation of the power supply leads to shut down of the overall system, damage to the power supply equipment and expensive load equipment, or to a fire in an extreme case. As the power supply provides the base for the entire electric and electronic circuits of the system to which it supplies the power, its reliability is very important. Protective features, which prevent serious damage when the power supply should fail, are important factors to be taken into consideration when selecting a power supply.

The PAD-L Regulated Power Supplies have been designed fully taking the above matters into consideration, as instruments of very high reliability. They employ premium quality components, with sufficient derating. They are incorporated with protector which lead them to "the safer side" should they fail. Individual protectors are explained in this section.

863574A

3-2. Explanation of Protective Circuits

(1) Overvoltage protector:

A limiting voltage can be set from the instrument front panel. If the output voltage exceeds the preset voltage, the input power switch is cut off. The operation time is approximately 50 msec.

(2) Voltage detection circuit:

When the rated voltage of the electrolytic filter capacitor is exceeded due to such erroneous operation as disconnected jumper of the terminal block on the rear panel or due to a failure of the rectifier circuit, the input power switch is instantaneously cut off.

(3) Current detection circuit:

When in such erroneous operation as that the jumper of the terminal block of the rear panel is inadvertently left disconnected or when the current limiting circuit has failed, the control transistors are cut off and at the same time the input power switch is cut off or the current is limited at approximately 120% of the rated current.

(4) Temperature detection circuit:

Detects temperature of the cooling package (semiconductor cooling unit). When temperature of the cooling fins have become higher than approximately 100°C due to ambient temperature rise or cooling fan failure, the input power switch is cut off.

(5) High-speed overvoltage protector (option):

When the output voltage has exceeded the preset voltage due to erroneous operation or an external pulse voltage,

803575A

a thyristor circuit connected between the output terminals instantaneously conducts to short-circuit the output and, at the same time, the input power switch is instantaneously cut off. The operation time is selectable from a range of several microseconds to several hundreds microseconds.

Model PAD-	8-50L	16-50L	20-40L	35-30L	55-20L
OVP type	OVP 16-50L	OVP 16-50L	OVP 35-60LN	OVP 35-60LN	OVP 55-20L

Model PAD-	70-15L	110-10L	160-7L	250-4.5L	
OVP type	OVP 110-10L	OVP 110-10L	OVP 250-10L	OVP 250-10L	

Table 3-1

(6) Power fuse:

Limits the input current.

(7) Output fuse:

Limits the output current.

Both fuses are current limiting type of fuses meeting the requirements of JIS and model-approved by the Electrical Appliance Control Ordinance. The fuses employ a ceramic insulation tube and silica sand arc killer, and are free of flame when blown out.

3-3. Operation Method of Overvoltage Protector (OVP)

Setting procedure

- (1) Turn the OVP potentiometer to the extreme clockwise position with a screwdriver.
- (2) Set the output voltage at the required operating point of the OVP.

803576A

- (3) Gradually turn counterclockwise the OVP potentiometer to the point where the input power switch is cut off.
- (4) Lower the output voltage and turn on the input power again and check once more the operating point of the OVP circuit before using the power supply for its load. (Once the OVP circuit has tripped, the input power switch can not be turned on again until a period of several seconds elapses.)

8035477A

SECTION 4. APPLICATIONS

4-1. Remote Sensing

Voltage drop caused by the load connection wire resistance and contact resistance can be compensated for.

1. Turn off the input power switch.
2. Disconnect the jumper wires from between +S and (+) terminals and between -S and (-) terminals on the instrument rear panel.
3. Connect the +S and -S wires to the point where the output voltage drop is required to be compensated for. (Use a shielded cable in order to prevent induction of ripple voltage. Connect the external shielding wire to the (+) or (-) line of the output.)
4. Be Sure to connect the load to the OUTPUT terminals. (Note that the remote sensing terminals must not be used to feed the output current.)

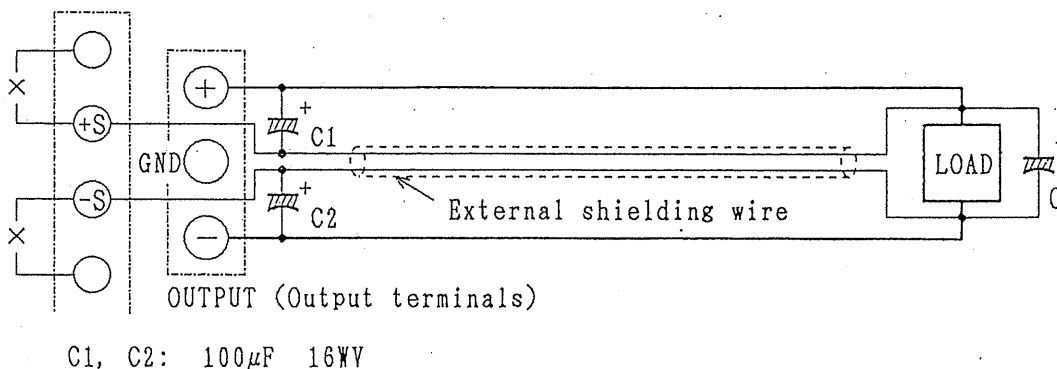

Figure 4-1

Notes: 1. By this remote sensing feature, up to approximately 1.2 V of voltage drop per one-way of connection wire can be compensated for. Note that, if the voltage drop is larger than 0.3 V, the maximum rated voltage is reduced by the corresponding amount.

189.4.11

803578B

2. If the load connection cable is longer than 3 - 5 meters, phase shift caused by inductance and capacitance of the cable wires becomes noticeable and the circuit may oscillate. In such a case, connect capacitors C1 and C2 and connect an electrolytic capacitor of several hundred microfarads in parallel with the load as shown in Figure 4-1.

4-2. Output Voltage Control with an External Voltage or Resistance

o Control with an external resistance - I

1. Turn off the input power switch. (Be sure to turn off the input power switch whenever connecting or disconnecting wires of the rear terminals.)
2. Disconnect the jumper from between terminal ③ and ④.
3. Connect a 100-ohm potentiometer and another potentiometer (R1) between terminals ④ and ⑤.
4. Set R1 at zero and so adjust the 100-ohm potentiometer that the output voltage becomes zero.

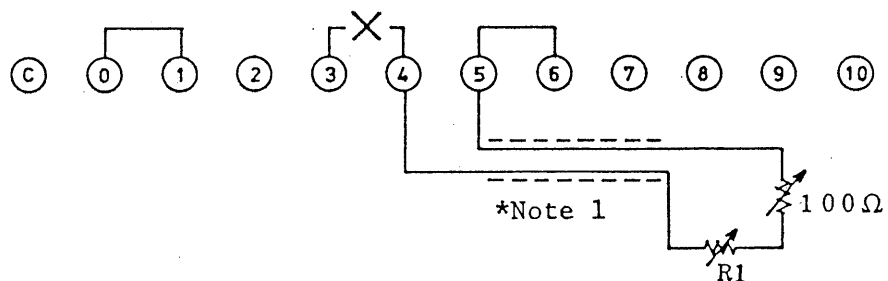

Figure 4-2

$$\text{Output voltage } E_o = \frac{E_{\text{max}} \cdot R_1}{10} \text{ [V]}$$

Where, $10 \geq R_1$ [k Ω]

E_{max} : Rated output voltage [V]

*Note 1: Use a 2-core shielded cable or a pair of stranded wires. Connect the shield wire to the "+" output terminal.

o Application

- o By using a fixed resistor and a potentiometer, the voltage can be varied by plus or minus several percent of the set voltage.
- o Resolution of the output voltage depends on resistor R_1 . Therefore, required resolution can be obtained by using an appropriate value of potentiometer for R_1 .
- o A programmed voltage can be obtained by varying the resistance with switch setting. (For this purpose, use switches of a closed circuit type or continuous type which do not cause momentary open circuit.)

o Control with an external resistance - II

(This method is a fail-safe method free from overshoots even when resistors are switched.)

1. Turn off the input power switch.
2. Disconnect the jumper from between terminals ⑤ and ⑥.
3. Connect the resistor (potentiometer R_2) between terminals ⑤ and ⑥.

8035804

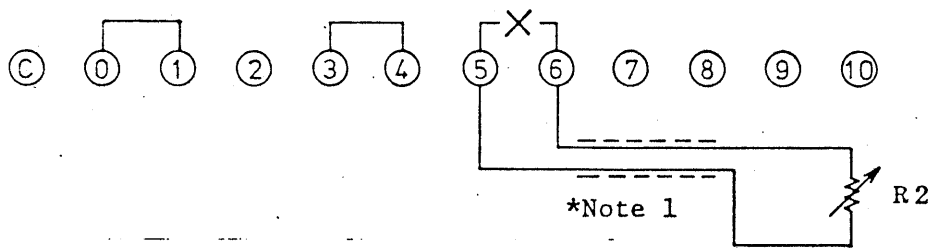

Figure 4-3

$$E_o = \frac{b}{a + R_2} \times E_{ref} \text{ [V]}$$

E_o : Output voltage

E_{ref} : Reference voltage, 0 to 10 V

R_2 : $0 \leq R_2 \leq \infty$ (infinite)

a, b : Constants (depend on model)

The output voltage (E_o) is inversely proportional to the resistance (R_2) as shown below. Therefore, when the circuit has become open due to switching of resistors or a failure, the resistance becomes infinity and the output is reduced to zero.

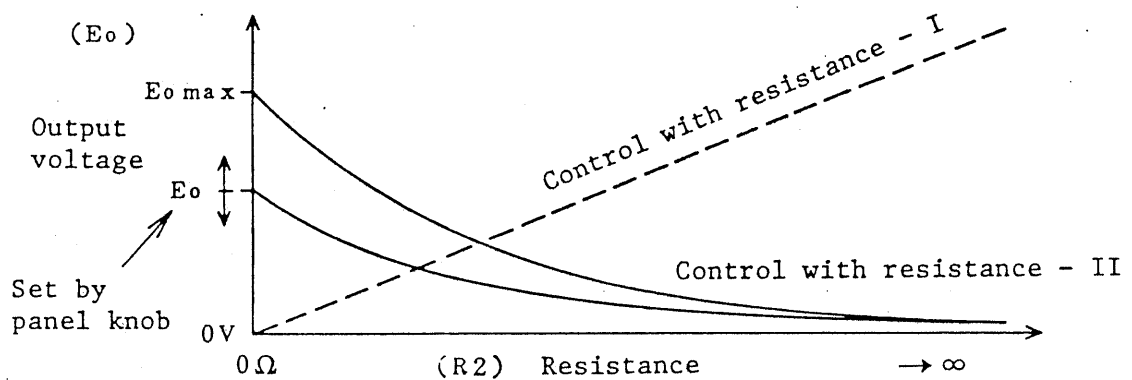

Figure 4-4

803581

- o Output voltage E_o can be calculated from R_2 and E_{ref} , using the above equation. E_{ref} can be set by means of the voltage setting knob on the front panel. (When the knob on the front panel is to be made ineffective. Use a "guard cap" (accessory, see page 12.)).
- o The primary objective of this mode of operation is to attain such a fail-safe feature that the output voltage drops when the output circuit is inadvertently made open. A disadvantage of this mode of operation is that a high resistor is required when programming for operation at low voltages. In general, a potentiometer of 0 - 200 k Ω or thereabout is used. (When using a high resistor, pay attention to its temperature coefficient and noise property.)

o Control with an external voltage

1. Turn off the input power switch.
2. Disconnect the jumper from between terminals ⑤ and ⑥.
3. Apply an external control voltage between terminals ⑥ and ⊕S. (Pay attention to the polarity.)

The terminal for the common line of the control voltage signal is ⊕S. The external control voltage signal must be of an isolated type. Note that the power supply may be damaged if the control voltage signal is not of an isolated type. When the output is controlled for both constant-current and constant-voltage simultaneously, the respective control voltage signals must be of an isolated type because the common lines of the two control circuits are not connected in common.

- * The instrument may be damaged if there is a wrong connection or an abnormally large voltage is applied. Check for them once more before turning on the instrument power.

88.8.26

803502-14

- o There is an offset voltage between the input control voltage and the output voltage as shown below.

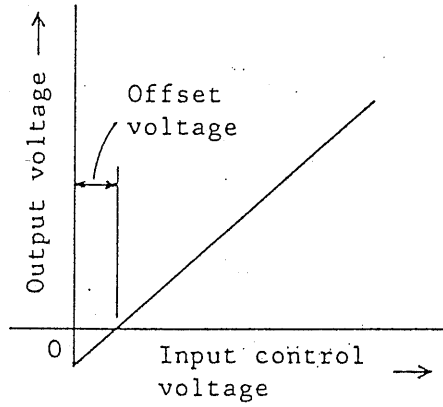

The input offset voltage can be adjusted with the output voltage offset control.

88.8.26

803582-2A

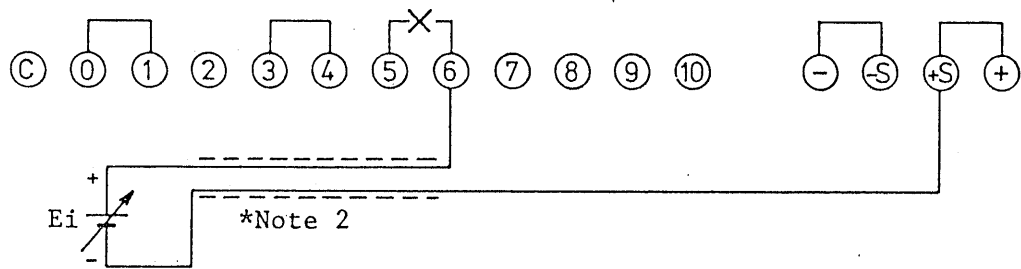

Figure 4-5

$$\text{Output voltage } E_o = \frac{E_{\text{max}} \cdot E_i}{10} \quad [\text{V}]$$

Where, $0 \leq E_i \leq 11 \text{ V}$

E_o : Output voltage [V]

E_i : Input control voltage [V]

E_{max} : Maximum rated voltage [V]

- Notes:
1. Make sure that the output voltage does not exceed the maximum rated voltage.
 2. Before this operation, set the OVP circuit in order to guard against overvoltage.
 3. Keep the input control voltage within a range of 0V to 11 V.
 4. The input resistance between terminals (6) and +S is 3 to 10 k Ω .
 5. Noise included in the input control voltage is amplified and reflected on the output voltage. Sufficiently reduce the noise component of the input control voltage.

*Note 2: Use a 2-core shielded cable or a pair of stranded wires. Connect the shield wire to the "+" output terminal.

8035 83A

4-3. On-off Control of Output

A. For voltage preset with voltage limit switch when output is off

1. Turn off the input power switch.
2. Connect an external switch between terminals ① and ②.
3. Turn on the input power switch. If the external switch is turned on, the output becomes almost zero. If it is turned off, the output power is delivered.

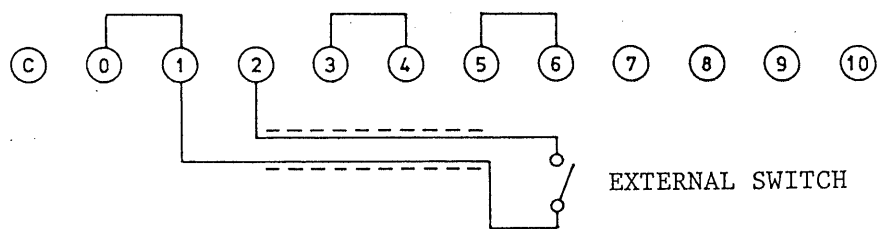

Figure 4-6

Note: When the output is in the off state, the output voltage of less than 0.6 V in the reverse polarity may be produced and a current of approximately 10 mA may flow depending on the type of the power supply. If such remaining voltage is not allowable, use method B explained in the subsequent paragraph. When the output is off, the current limit switch cannot be used.

B. To make the output voltage accurately zero volts

1. Turn off the power switch.
2. Connect an external switch and a 100-ohm potentiometer between terminals ④ and ⑤.
3. Turn on the input power switch. Next, turn on the external switch.

803584

4. Adjust the output voltage to zero volts with the potentiometer.
5. If the external switch is turned on, the output voltage becomes zero; if it is turned off, the output power is delivered.

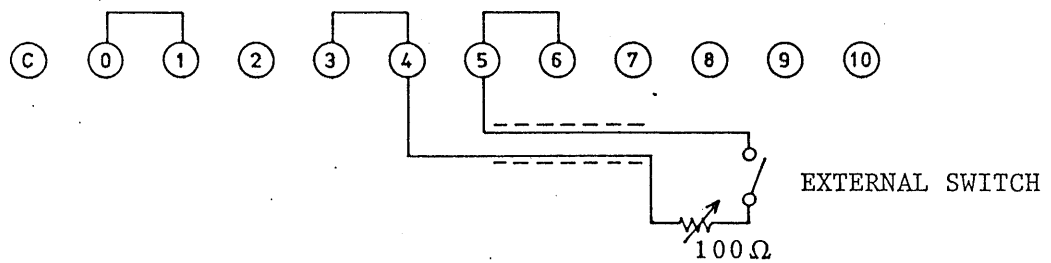

Figure 4-7

Note: When the output is off, the voltage limit switch cannot be used.

4-4. Output Current Control with an External Voltage or Resistance

o Control with an external resistance

1. Turn off the input power switch. (Be sure to turn off the power switch whenever connecting or disconnecting wires of the rear terminals.)
2. Disconnect the jumper from between terminals ① and ②.
3. Connect R2 and R3 potentiometers between terminals ① and ②.
4. Adjust the 10-ohm potentiometer so that the output current becomes zero when R2 is zero.

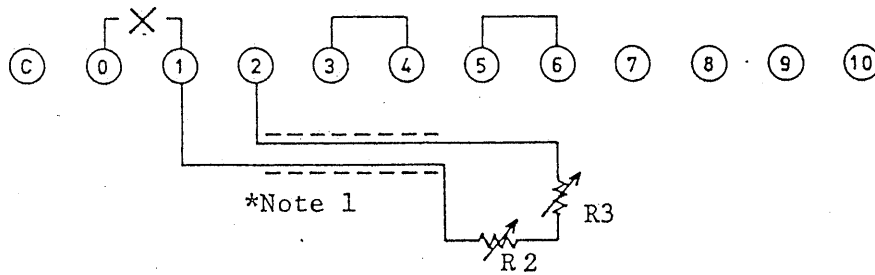

Figure 4-8

$$\text{Output current } I_o = \frac{R_2 \cdot I_{\text{omax}}}{1000} \text{ [A]}$$

*Note 2

Where, $R_2 \leq 1000 \text{ } [\Omega]$ R_3 : Approx. 10 - 30 $[\Omega]$
 I_{omax} : Rated output current [A]

*Note 1: Use a 2-core shielded cable. Connect the shield wire to the "+" output terminal.

*Note 2: Linearity between R_2 and I_o is approximately 5%.

o Control with an external voltage

1. Turn off the power switch.
2. Disconnect the jumper from between terminals ① and ②.
3. Throw switch SW1 on PCB A-200 board to the upper position as shown in Figure 4-10. For location of the PCB, see Figure 6-1.
4. Connect electrolytic capacitor between terminals ① and ②.
5. Apply the external control voltage between terminals ① and ②.

The potential of control common terminal ② is almost identical with that of output terminal (+). The external control voltage signal must be of an isolated type.

88.8.21
803586B

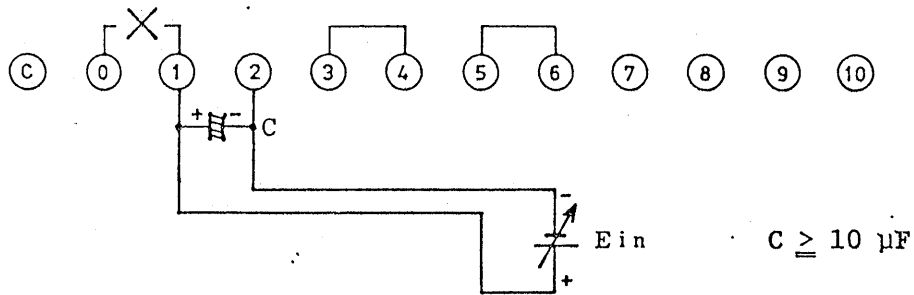

Figure 4-9

$$I_{out} = \frac{E_{in}}{R} \text{ [A]}$$

Where, $E_{in} \text{ [V]} \leq E_{inmax}$

I_{out} : Output current

E_{in} : Input current

R: Detecting resistor

E_{inmax} : Maximum input voltage

Type PAD-	8-50L	16-50L	20-40L	35-30L	55-20L
R [Ω]	0.01	0.01	0.01	0.033	0.05
E_{inmax} [mV]	550	550	440	1090	1100

Type PAD-	70-15L	110-10L	160-7L	250-4.5L	
R [Ω]	0.03	0.1	0.15	0.1	
E_{inmax} [mV]	495	1100	1155	495	

Table 4-2

- Notes:
1. Make sure that the output current does not exceed the maximum rated current.
 2. The input voltage (external control voltage) must be within a range of 0 V to the maximum input voltage.
 3. Noise included in the input voltage is amplified and reflected on the output voltage. Sufficiently reduce the noise component of the input signal.

803581A

4. Be sure to throw switch SW1 to the original state (lower position) after the operation in the remote control mode is over.

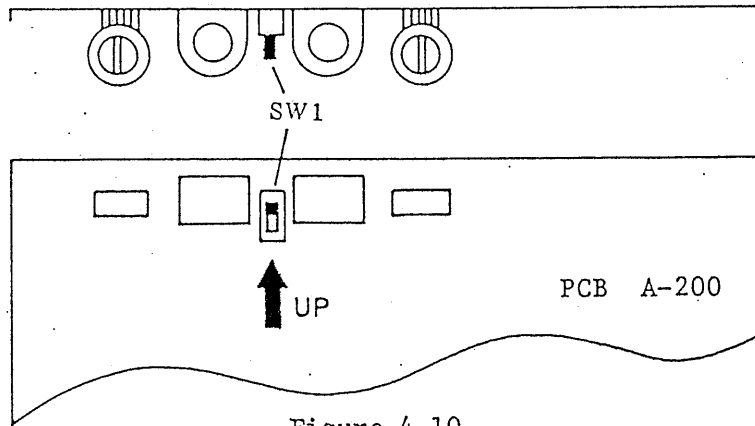
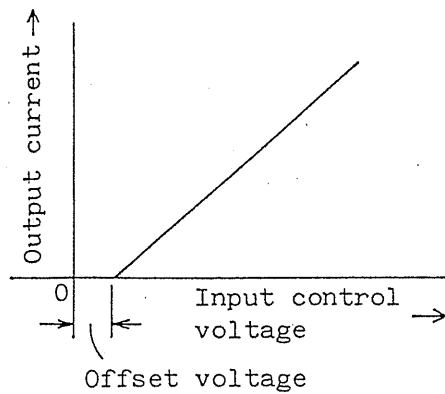

Figure 4-10

- o There is an offset voltage between the input control voltage and the output current as shown below.



For particular applications which do not tolerate this offset voltage, adjust it with the output current offset control.

4-5. One-control Parallel Operation

One master unit and any number of slave units can be operated in parallel to increase the current capacity, controlled by one unit (master unit) for operation.

1. Turn off the input power switch.
2. Disconnect the jumper from between terminals ① and ② of each slave unit.
3. Connect terminal ③ of the master unit to terminals ① of all slave units.
4. Connect parallel the output terminals of all units, for each polarity.

88.8.26

803588B

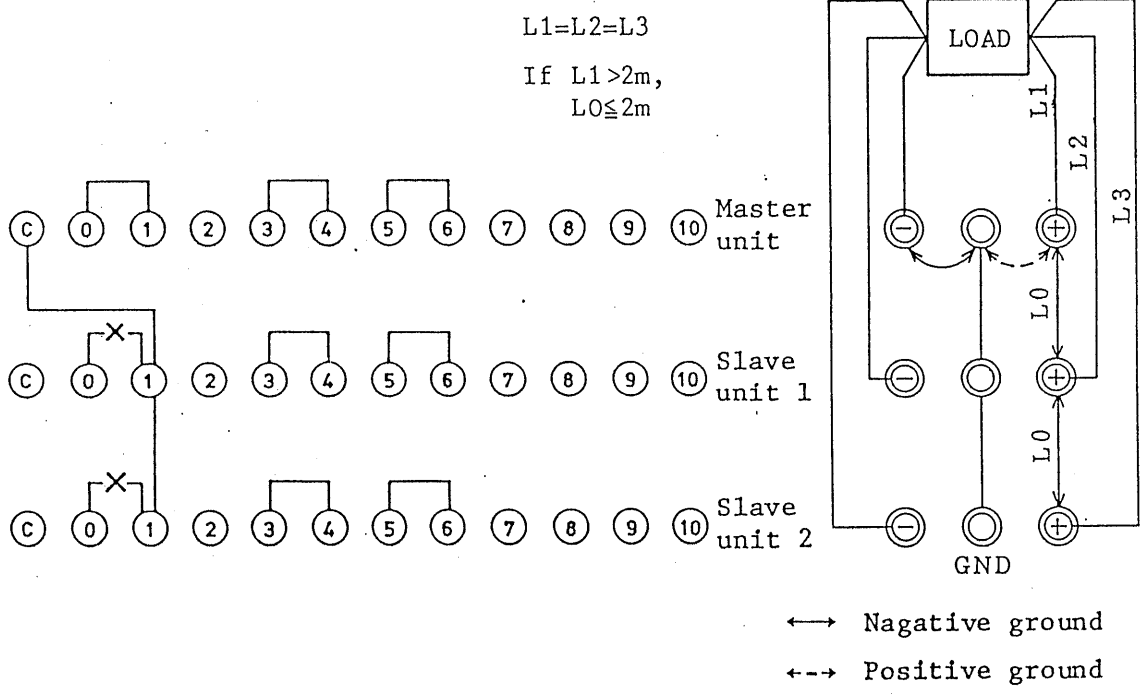

Set the constant-voltage setting knobs of all slave units to maximum position. Of the master unit, the green LED lamp lights to indicate the constant-voltage mode; of the slave units, the red LED lamps light to indicate the constant-current mode.

Figure 4-11

5. For one-control parallel operation, connect the GND terminals as shown in Figure 4-11.
6. For one control parallel operation with remote sensing, disconnect the jumper wires from between +S and + terminals and -S and - terminals of the master unit, and make required connections for the master unit as explained in 4-1 "remote sensign".

Note: Set the constant-voltage setting knobs of the slave units to the maximum position. For the wire gauges for the required currents, see Table 2-1.

508589C
 6 5 18

4-6. One-control Series Operation

One master unit and any number of slave units can be operated in series to obtain a higher output voltage (up to 250 V), controlled by one unit (master unit) for operation.

1. Turn off the input power switch.
2. Disconnect the jumper from between terminals ⑤ and ⑥ of each slave unit.
3. Connect external resistors as shown in Figure 4-12.
4. Connect the rear output terminal as shown in Figure 4-13.
5. Set the current setting knobs of all slave unit in the maximum position.

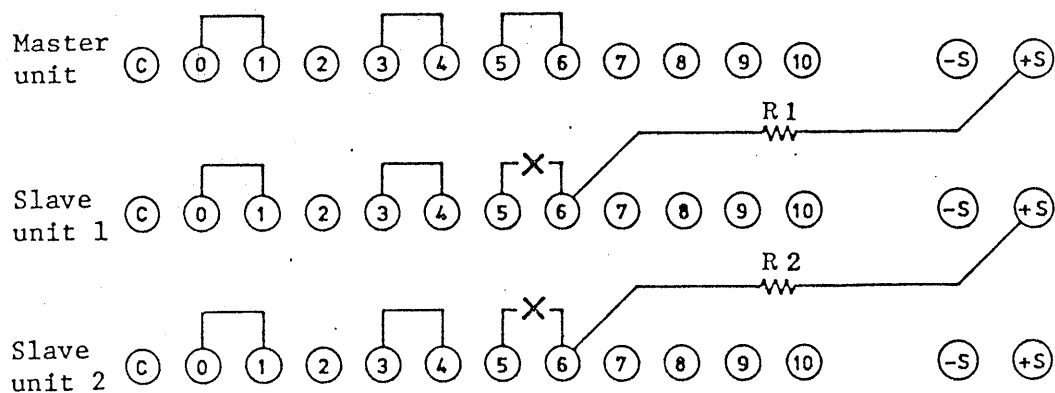

Figure 4-12. Rear terminal connections

803590A

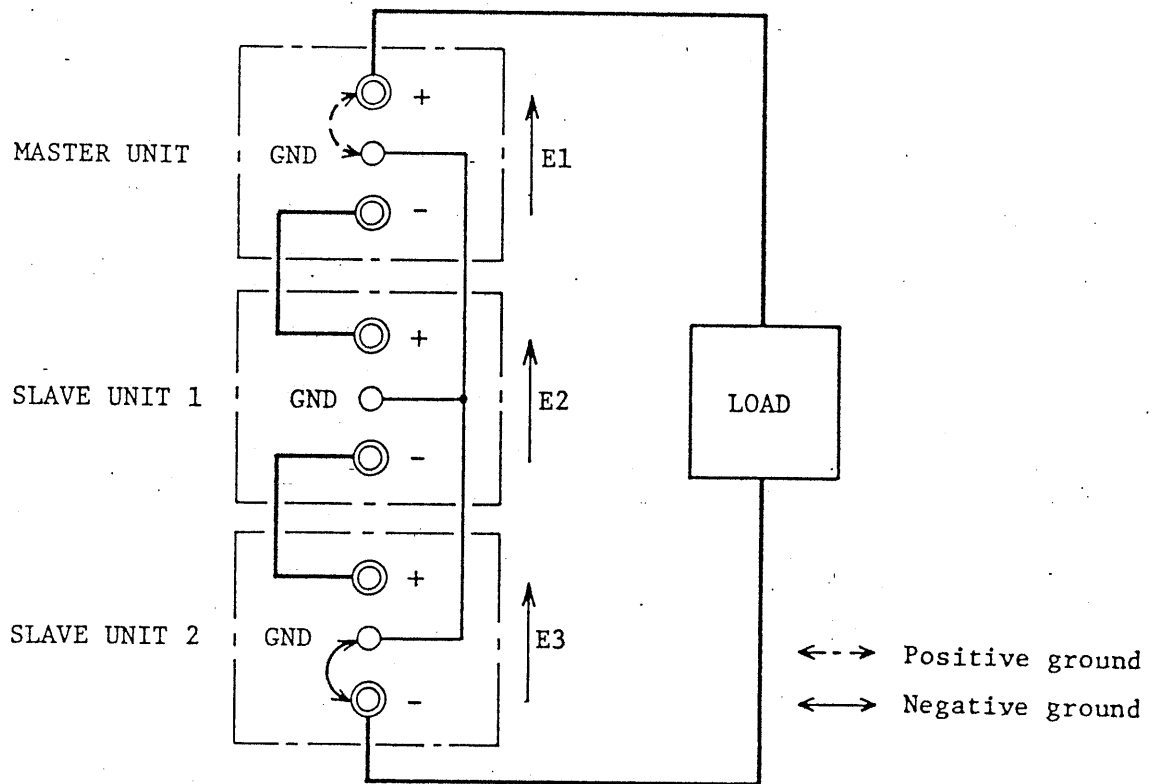

Figure 4-13. Rear output terminal connections

Note: Connect the ground jumper on the front panel, without PAD8-50L, PAD16-50L and PAD20-40L.

Determination of R1 and R2

$$R1 = \left(\frac{E1}{E2} \times A \right) - B$$

$$R2 = \left(\frac{E2}{E3} \times C \right) - D$$

Where, $R1, R2 \geq 0$ [k Ω]

E1 [V]: Output voltage of master unit

E2 [V]: Output voltage of slave unit 1

which is determined by E1.

A, B: Constants of slave unit 1 (See Table 4-2)

C, D: Constants of slave unit 2 (See Table 4-2)

PAD	8-50L	16-50L	20-40L	35-30L	55-20L
A, C	2.7	5.2	6	12	30
B, D	3.4	3.3	3	3.4	5.5

PAD	70-15L	110-10L	160-7L	250-4.5L	
A, C	52	108	159	248	
B, D	7.4	9.8	9.8	9.8	

Table 4-3

- Notes:
1. Make the total series output voltage not higher than 250 V. (PAD160-7L, PAD250-4.5L: 500 V)
 2. Set the constant-current setting knobs of the slave units to maximum position.
 3. Pay attention to the wattage of the external resistors (R1 and R2).
 4. Values of R1 and R2 may slightly differ from the calculated value. Adjust the values of R1 and R2 as required.
 5. If the master unit is PAD8-50L, then $R1 = 0$, and slave maximum output voltage is limited to 80%. For PAD8-50L only one-controlled series operation, so adjust R220 on PCB A-200 in slave, that slave output voltage is as same as master output voltage.

Applications:

1. For one-control series operation with remote sensing, disconnect the jumper from between terminals +S and "+" terminals of the master unit and that from between -S and "-" terminals of slave unit 2 (the last slave unit). (See 4-1 "Remote Sensing.")
2. One-control operation is possible also among different models of this series of power supplies. In this case, the maximum output current is limited by that of the unit of the smallest current rating. Therefore, it is recommended to use the unit of the smallest current rating as the master unit.

803592A

4-7. Constant-current Charge/Discharge of Battery or Capacitor

- o Charge (constant current)

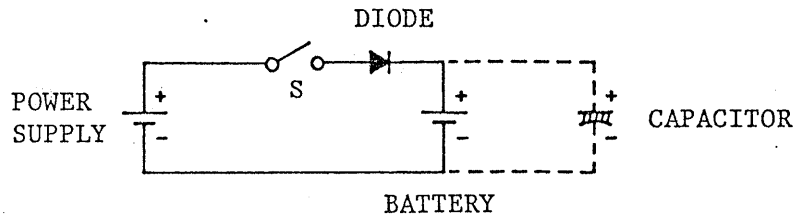

Figure 4-14

1. Keeping depressed the current/voltage limit switch, set the charge end voltage with the constant voltage setting knob and the charge current with the constant-current setting knob.
2. Close switch S so that the charging operation starts. When the charge end voltage is reached, the charging operation stops automatically. (The power supply employs a potentiometer burn protection circuit.)

Notes: 1. Connect the battery in the same polarity with the power supply. (If it is connected in the reverse polarity, the power supply may be damaged.)

2. If the output voltage of power supply is lower than the battery voltage or if the power switch is off, a current of several hundreds milliamperes flows from the battery into the power supply. If this current is not allowable, connect a diode in series with the battery as shown in Figure 4-14.

3. When PAD8-50L, PAD16-50L and PAD20-40L is connected the battery, the output current flows backward a moment, but the unit is not destroyed. (When the output voltage is almost same voltage as battery, the output current does not flow backward.)

863593A

- o Discharge (constant current)

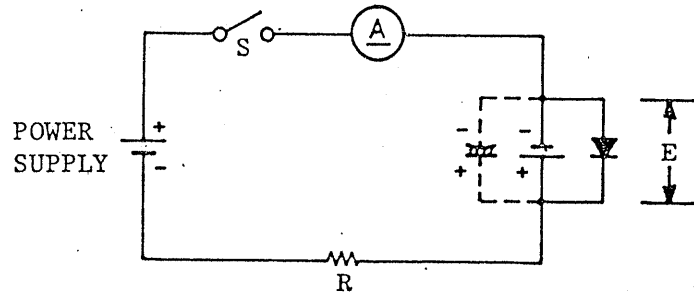

Figure 4-15

Resistance of R:
$$R = \frac{E[V]}{I[A]}$$

Power consumption by R:
$$P = I^2R [W]$$

where, E: Terminal voltage of battery or capacitor when starting discharge

R: Discharge resistor

I: Discharge current (constant current)

D: Reverse current blocking diode

1. Set the output voltage of the power supply with the constant-voltage setting knob to a voltage higher by several volts than the terminal voltage of the battery or capacitor which is to be discharged. (Once this setting is done, constant-current discharge is done until the voltage of the battery or capacitor becomes zero.)
2. Calculate the resistance of the discharge load resistor (R). Pay attention to the wattage of the resistor.
3. Keeping depressed the current/voltage limit switch, set the discharge current with the constant-current setting knob.

8035-94A

4. Close switch S. Constant-current discharge operation will start.

- Notes:
1. To stop discharge, open switch S. (Even when the input power switch of the power supply is cut off, the discharge current flows through the diode which is connected in parallel with the output circuit of the power supply.)
 2. Be sure to connect the discharge load resistor (R). (If the battery or capacitor is directly connected, the power supply may be damaged.)
 3. Be sure to connect the reverse current blocking diode.

4-8. Remote Turning Off of The Power Switch

To turn off the power switch, short-circuit between terminals ⑦ and ⑧ on the rear terminal board.

Note: As terminals ⑦ and ⑧ are at the potential of the "+" terminal of the filter capacitor, a floated (isolated) external contact signal is required for the remote control signal.

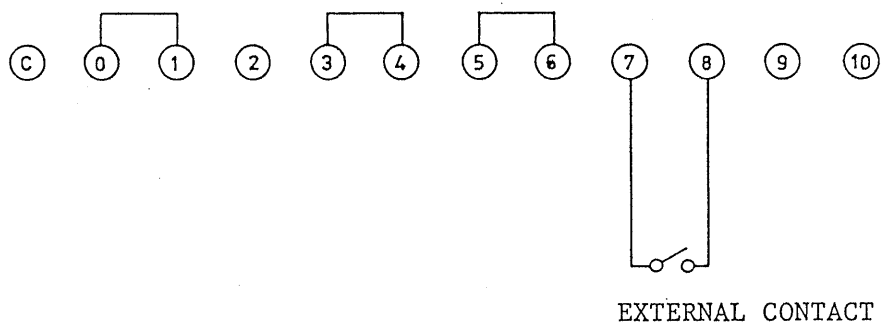

Figure 4-16

803594

SECTION 5. THEORY OF OPERATION

5-1. Description of Pre-regulation Circuit

Before describing the operating principles of individual circuits of the power supply, history of variable regulated DC power supplies are very briefly introduced in the following.

Figure 5-1 shows a series control circuit. This circuit, as compared with other types of control circuits, has a higher control accuracy and provides an output of higher quality. The output voltage is variable for a wide range. Therefore, this circuit is widely used for variable DC power supplies. This circuit, however, has a disadvantage that, when the output power is supplied to a load at a low voltage, V_{CE} increases and consequently collector loss P_C ($P_C = V_{CE} \times I_C$) increases and, therefore, rectifier voltage V_C is required to be varied with respect to the output voltage.

Figure 5-2 shows a power supply circuit which employs a relay system. Variation of the output voltage is detected and transformer taps are switched with a relay circuit to compensate for

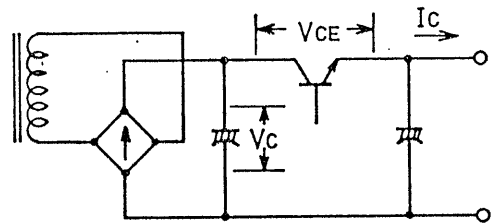

Figure 5-1
Series-controlled power supply

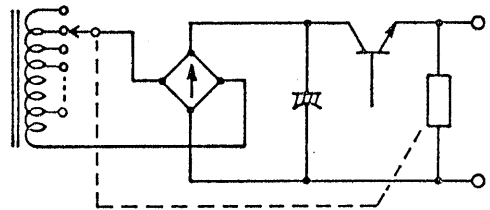

Figure 5-2
Variable regulated DC power supply circuit with relay switching.

803596A

output variation. The PAC Series Power Supplies employs this system. This system provides excellent power supplies up to approximately 200 watts. For larger power supplies, however, this relay system has such disadvantages that mechanical contacts have limited life and require maintenance, a number of relays are required to reduce the collector loss, and consequently the reliability falls and the cost rises. To solve the problem, solid-state switching circuit has become most common.

Figure 5-3 shows the SCR system employed by the PAD Series Power Supplies. This system provides a fast response and V_{CE} can be maintained almost constant by phase control and, therefore, it enables high-accuracy large-rating variable power supplies. Thus, a large number of this type of power supplies have been manufactured by Kikusui. However, problems have risen regarding increase of ripple current of the electrolytic capacitor as the filter circuit is a capacitor input type, the surge current of SCRs, and overheating due to copper loss of the transformer when the power factor has become poor.

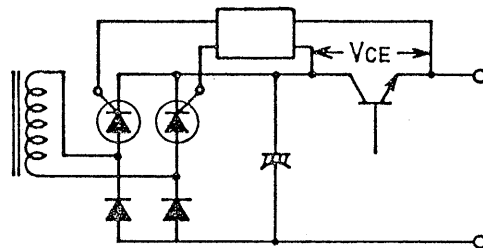

Figure 5-3
Variable regulated DC power supply with SCRs

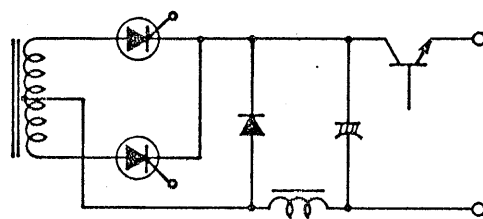

Figure 5-4
Principle of PAD-L Series Power Supplies

803597A

The PAD-L Series Power Supplies have solved the above problems by using a choke-input type filter circuit, and are the most reliable variable regulated DC power supplies available.

5-2. Controlled Rectifier Circuit and Filter Circuit

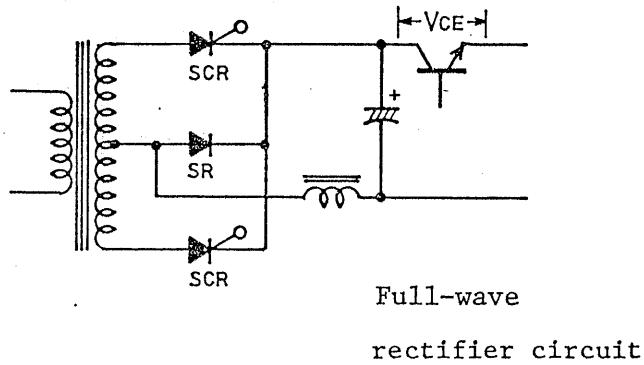

Figure 5-5

- o This circuit rectifies the current with phase-controlled SCRs and the collector-emitter voltage of the series control transistor is maintained constant to reduce the collector loss.
- o The filter circuit is a single-stage inductor-L choke input type.
- o SR is a freewheeling diode, which is used as the load (filter circuit) of the rectifier circuit, is inductive in order to commutate the energy stored in the reactor and turn off the SCRs.
- o This circuit, when the conducting angle of SCRs has become narrower, can prevent degradation of power factor (which is inherent to the phase-controlled circuit) more effectively as compared with the capacitor-input filter circuit. It also

8635987

solves the problems of ripple current of electrolytic filter capacitor and overheating of the transformer, and reduces the rectified output ripples. The PAD-L Series Power Supplies also employ a bridge rectifier circuit.

5-3. Phase Control Circuit

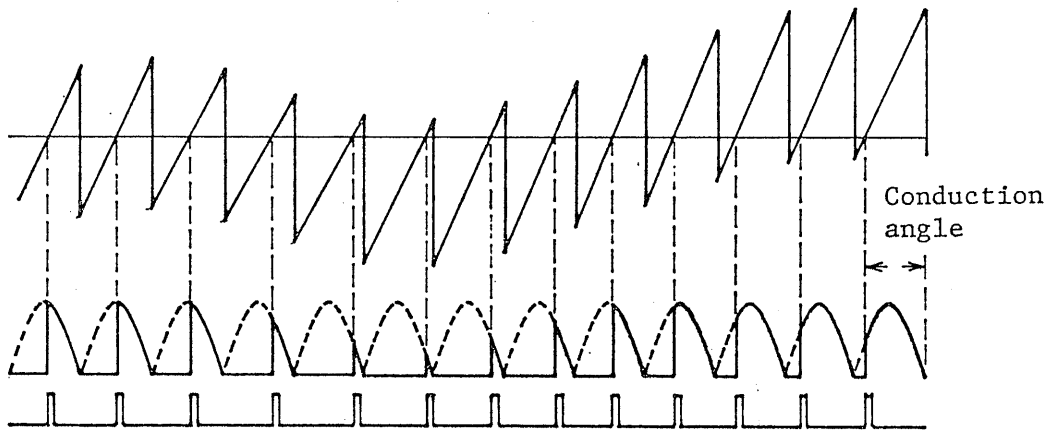
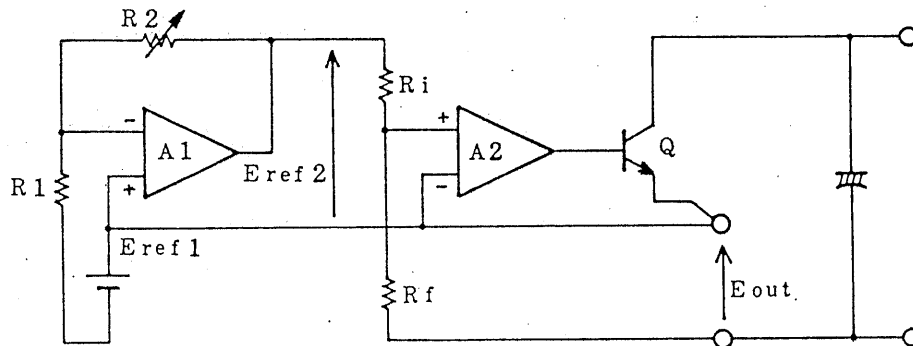

Figure 5-6

This circuit is a pulse phase modulator which operates in synchronization with the AC line frequency. When the collector-emitter voltage (V_{CE}) is large, the generated pulse signal is for a wider conduction angle and, when the voltage is lower, the signal is for a narrower conduction angle and, thus, the circuit so controls SCRs that V_{CE} becomes constant.

803599A

5-4. Constant-voltage Circuit



- Eref 1: Reference voltage 1.
- Eref 2: Reference voltage 2
- Ri: Input resistance
- Rf: Feedback resistance

Figure 5-7

Output voltage E_{out} can be expressed as follows (A1 is an ideal amplifier):

$$E_{out} = - \frac{R_f}{R_i} E_{ref 2}$$

Thus, the output voltage depends only on $E_{ref 2}$, R_i and R_f . The output voltage is linearly proportional to R_f and $E_{ref 2}$. For this power supply, $E_{ref 2}$ is varied to control the output voltage. $E_{ref 2}$ is produced by amplifying $E_{ref 1}$, and this voltage is linearly varied by R_2 .

To obtain a stable output voltage, such components as $E_{ref 1}$ diode, R_1 , R_2 , R_i , R_f , A1 and A2 must be sufficiently stable against change in external conditions. This power supply employs for the $E_{ref 1}$ diode a zener diode of excellent temperature

803000

characteristics. The resistors are metal-film resistors and wound-wire resistors of excellent temperature coefficient and aging characteristics. Amplifiers A1 and A2 employ monolithic ICs which ensure high gain, wide band and low drift.

The major factors caused by line voltage variation are variation of the operating point of the error amplifier and variation of the reference voltage due to dynamic resistance of the reference diode. To guard against these variations, a stabilized internal auxiliary voltage source is used. Load variation ($\partial V_o/\partial I_o$: output variation caused by output current variation) is affected by output impedance (internal resistance) Z_o . (See Figure 5-8.)

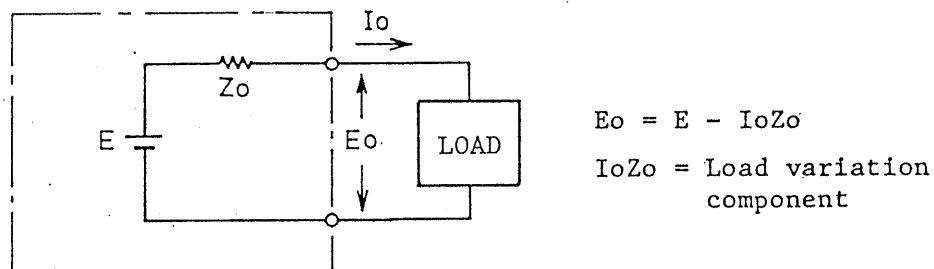

Figure 5-8

Denoting by A the open loop gain attained by error amplifier A2 and power transistor Q, output impedance Z_o can be expressed as follows:

$$Z_o = \frac{R_o}{1 + AB}$$

where, $B = \frac{R_i}{R_f + R_i}$

R_o : Output impedance of the circuit when no error amplifier is connected

The above equation indicates that the output impedance is improved to $1/(1+AB)$ by connecting amplifier A2 and effecting a feedback circuit.

803301

5-5. Constant-current Circuit

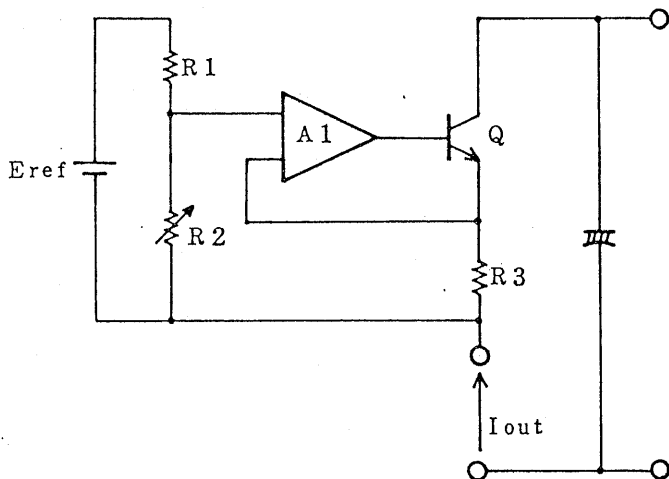

Figure 5-9

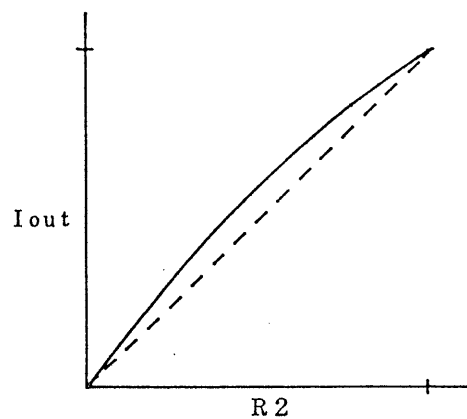

Figure 5-10

- Eref: Reference voltage for constant current
- R2: Output current control potentiometer
- R3: Output current detection resistor

Output current I_{out} can be expressed as follows (A1 assumes an ideal amplifier):

$$I_{out} = \frac{R2}{R3(R1 + R2)} \times E_{ref}$$

This equation indicates that the output current depends on E_{ref} , $R1$, $R2$ and $R3$. Of this power supply, the output current is controlled by varying $R2$. Note that the relationship between $R2$ and I_{out} is not linear as indicated with a solid line in Figure 5-10.

To ensure a stable output current, E_{ref} , $R1$, $R2$ and $R3$ must be sufficiently stable against change in external conditions (line voltage change, ambient temperature change, aging, and load change). Error amplifier A1 must be a high-gain wide-band DC amplifier with less drift.

803602A

Of the constant-current circuit, the larger the output impedance (Z_{out}), the smaller is the load variation ($\partial I_o / \partial V_o$: output current variation caused by output voltage variation). (See Figure 5-11).

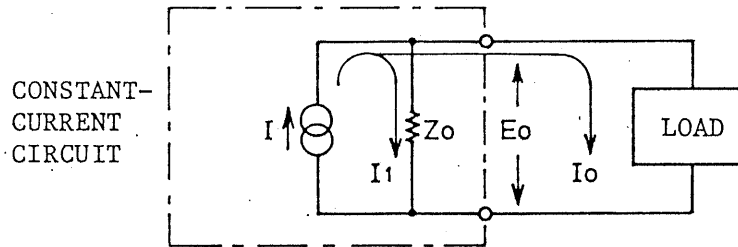

$$I_o = I - I_1$$

where, $I_1 = E_o / Z_o =$ Load current variation component

Figure 5-11

Denoting by g_m the mutual conductance attained by error amplifier A2 and power transistor Q, output impedance Z_o can be written as follows:

$$Z_o = (1 + g_m R_3) R_o$$

In this equation, R_o is the output impedance of the circuit before connecting the error amplifier. This equation indicates that the output impedance is improved by $(1 + g_m R_3)$ times by connecting amplifier A2 and providing negative feedback.

803603

5-6A. Differences from Ideal Constant-voltage Supply

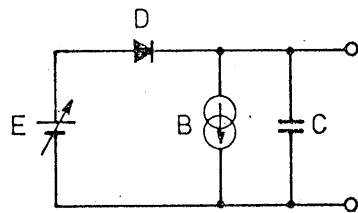

- E: Ideal constant-voltage supply
- D: Ideal diode
- B: Internal bleeder circuit
- C: Capacitor

Figure 5-12. Equivalent circuit of series-controlled constant-voltage DC power supply

- o Cannot sink current:

Figure 5-12 shows an equivalent circuit of a series-controlled constant-voltage power supply of the type used for this and other power supplies. An ideal diode is connected in series. This type of power supply is for a load of such type that it simply drains the current and does not send back the current. For such load as a battery which sends back a current, however this power supply cannot sink such current.

This problem can be solved by using a parallel-controlled power supply or one which has a bi-polarity output. Such power supplies, however, will provide less efficiency and high cost for the same power.

The problem can be solved by connecting a resistor in parallel with the load and feeding in the resistor a current larger than the maximum reverse current. When the reverse current is small, the problem may be solved by connecting an electrolytic capacitor in parallel with the load. When the load is an inverter, a filter circuit may be provided in the input circuit to reduce the reverse current.

803604A

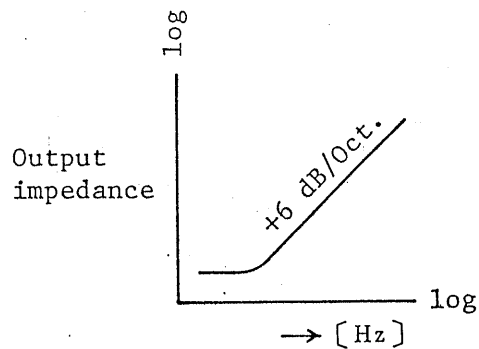

Figure 5-13

Frequency vs output impedance characteristics

- o Output impedance is not infinity, with certain frequency characteristics:

Figure 5-13 shows that the output impedance (internal resistance) of this power supply increases as the frequency increases. This is because the gain of the loop including the error amplifier decreases. Better frequency characteristics, as well as DC output impedance characteristics such as for load variation, are a desirable feature for the power supply.

This feature must be such that not only the high gain region of the error amplifier is extended to a higher frequency range but also the phase characteristics are correct.

A shorter transient response time means better frequency characteristics of output impedance. Transient response time is an index for evaluation at the time range and output impedance is that at the frequency range.

5-6B. Difference from Ideal Constant-current Power Supply

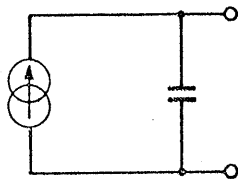

Figure 5-14

803605A

Figure 5-14 shows an equivalent circuit of this power supply operating as a constant-current source. A capacitor is connected in parallel with an ideal power supply.

There is no problem when the load is resistive. However, if the load is of such nature that it varies rapidly, pay attention to the fact that the output voltage also varies rapidly and the charge/discharge current of the capacitor is superimposed on the output current.

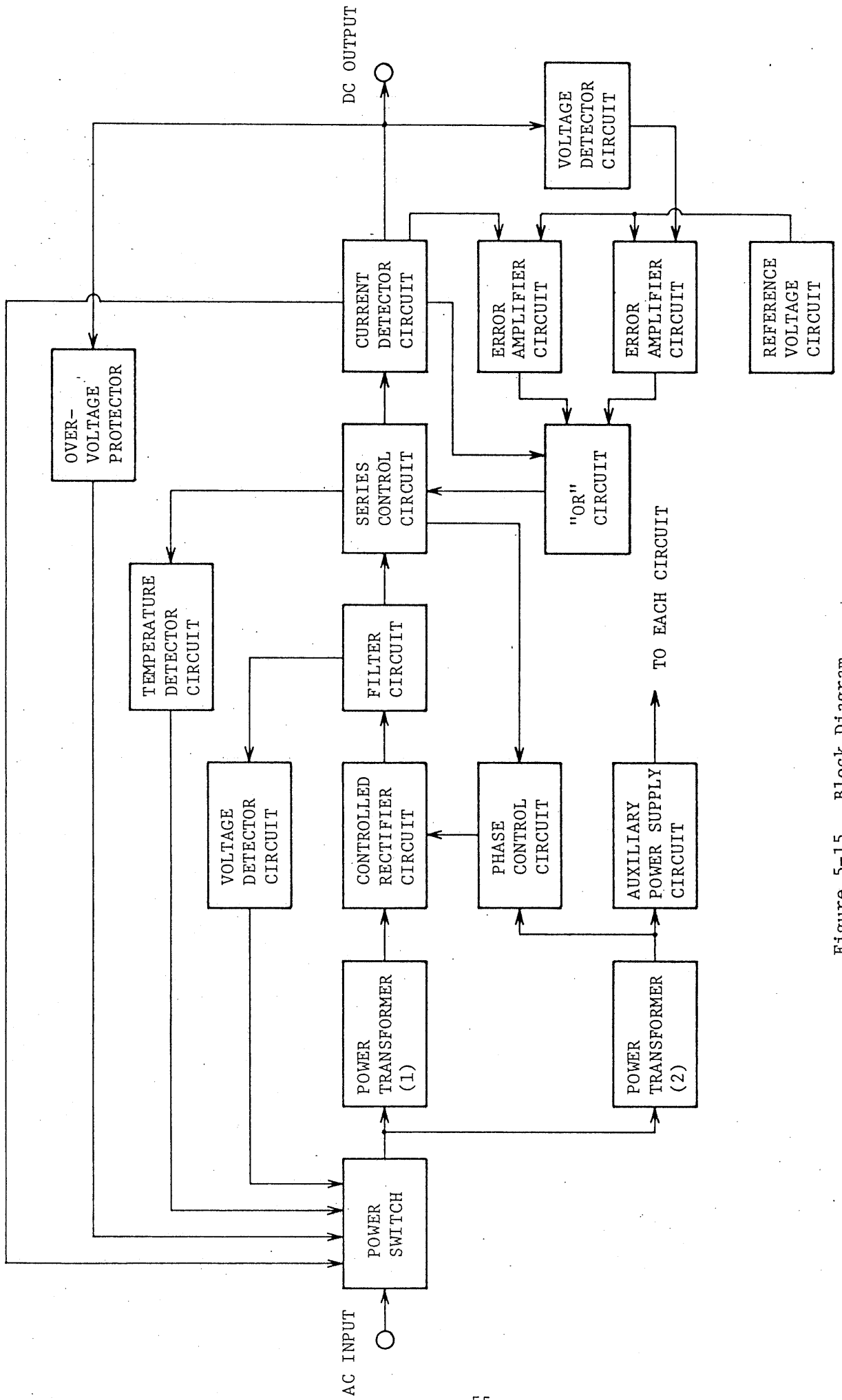

Figure 5-15. Block Diagram

803607

SECTION 6. MAINTENANCE

6-1. Inspection and Adjustment

Periodically inspect and adjust the power supply so that it maintains its initial performance for a long time.

6-1-1. Removing Dust and Dirt

6-1-2. Inspecting the Power Cord and Plug

6-1-3. Calibrating the Voltmeter

6-1-4. Calibrating the Ammeter

6-1-5. Calibrating the Current/Voltage Limit Switch

6-1-6. Adjusting the Maximum Variable Constant-voltage Range

6-1-7. Adjusting the Maximum Variable Constant-current Range

6-1-1. Removing Dust and Dirt

When the instrument panel has become dirty, lightly wipe it with a cloth moistened with diluted neutral soapsuds and, then, wipe it with a dry cloth. Do not use benzine or thinner. Blow away dust collected inside the instrument and in the ventilation holes of the casing, using a compressed air or a vacuum cleaner.

6-1-2. Inspecting the Power Cord and Plug

Check for that the vinyl cover of the cord is not damaged. Check the plug for play, loose screws and damage.

6-1-3. Calibrating the Voltmeter

Connect an external voltmeter of an accuracy of 0.5% or better to the output terminals, set the output voltage at the value indicated on Table 6-1, and calibrate the instrument voltmeter

199.9

803668AB

with R101 at the right-hand section on the front panel.
(See the panel illustration on page 15.)

6-1-4. Calibrating the Ammeter

Connect an external ammeter of an accuracy of 0.5% or better in the output circuit, set the output current at the value indicated on Table 6-1, and calibrate the instrument ammeter with R102 at the right-hand section on the front panel. (See the panel illustration on page 15.)

6-1-5. Calibrating the Current/Voltage Limit Switch

o Calibration of limit current

Set the output current at the value indicated on Table 6-1. Press the current/voltage limit switch and so adjust R253 that the ammeter indicates the set current value.

o Calibration of limit voltage

Set the output voltage at the value indicating on Table 6-1. Press the current/voltage limit switch and so adjust R209 that the voltmeter reads the set voltage value. (See Table 6-1.)

6-1-6. Adjustment of Maximum Variable Constant-voltage Range

Connect to the output terminals an external voltmeter of an accuracy of 0.5% or better, set the constant-voltage setting knob in the maximum position (extremely clockwise position), and so adjust R220 on PCB A-200 that the instrument voltmeter reads the value indicated on Table 6-1.

803669A

6-1-7. Adjustment of Maximum Variable Constant-current Range

Connect in the output circuit an external ammeter of an accuracy of 0.5% or better, set the constant-current setting knob in the maximum position (extremely clockwise position), and so adjust R249 on PCB A-200 that the instrument ammeter reads the value indicated on Table 6-1. (See Figure 6-1.)

6-1-8. Adjustment of V_{CE} of Series Transistor

Maintain constant the AC input voltage at 100 V (200 V) Connect a load and apply the rated voltage and feed the rated current. In this state, connect a mean-value-indicating voltmeter between positive terminal of filter capacitor and "+" output terminal, and so adjust R326 that the voltmeter reads the value indicated on Table 6-1. (See Figure 6-1.)

PAD		8-50L	16-50L	20-40L	35-30L	55-20L
Voltmeter adj	R101	8 V	16 V	20 V	35 V	56 V
Ammeter adj	R102	50 A	50 A	40 A	30 A	20 A
Current limit adj	R253	50 A	50 A	40 A	30 A	20 A
Voltage limit adj	R209	8 V	16 V	20 V	35 V	56 V
Maximum voltage adj	R220	8.5 V	16.5 V	20.5 V	35.6 V	56.5 V
Maximum current adj	R249	52 A	42 A	42 A	31 A	20.5 A
VCE adj	R326	3.9 V	3.9 V	4.1 V	6.1 V	8.1 V

PAD		70-15L	110-10L	160-7L	250-4.5L	
Voltmeter adj	R101	70 V	110 V	160 V	250 V	
Ammeter adj	R102	15 A	10 A	7.0 A	4.6 A	
Current limit adj	R253	15 A	10 A	7.0 A	4.6 A	
Voltage limit adj	R209	70 V	110 V	160 V	250 V	
Maximum voltage adj	R220	72 V	112 V	165 V	260 V	
Maximum current adj	R249	15.5 A	10.2 A	7.5 A	4.7 A	
VCE adj	R326	12.5 V	13.1 V	13.2 V	30.5 V	

Table 6-1

803611

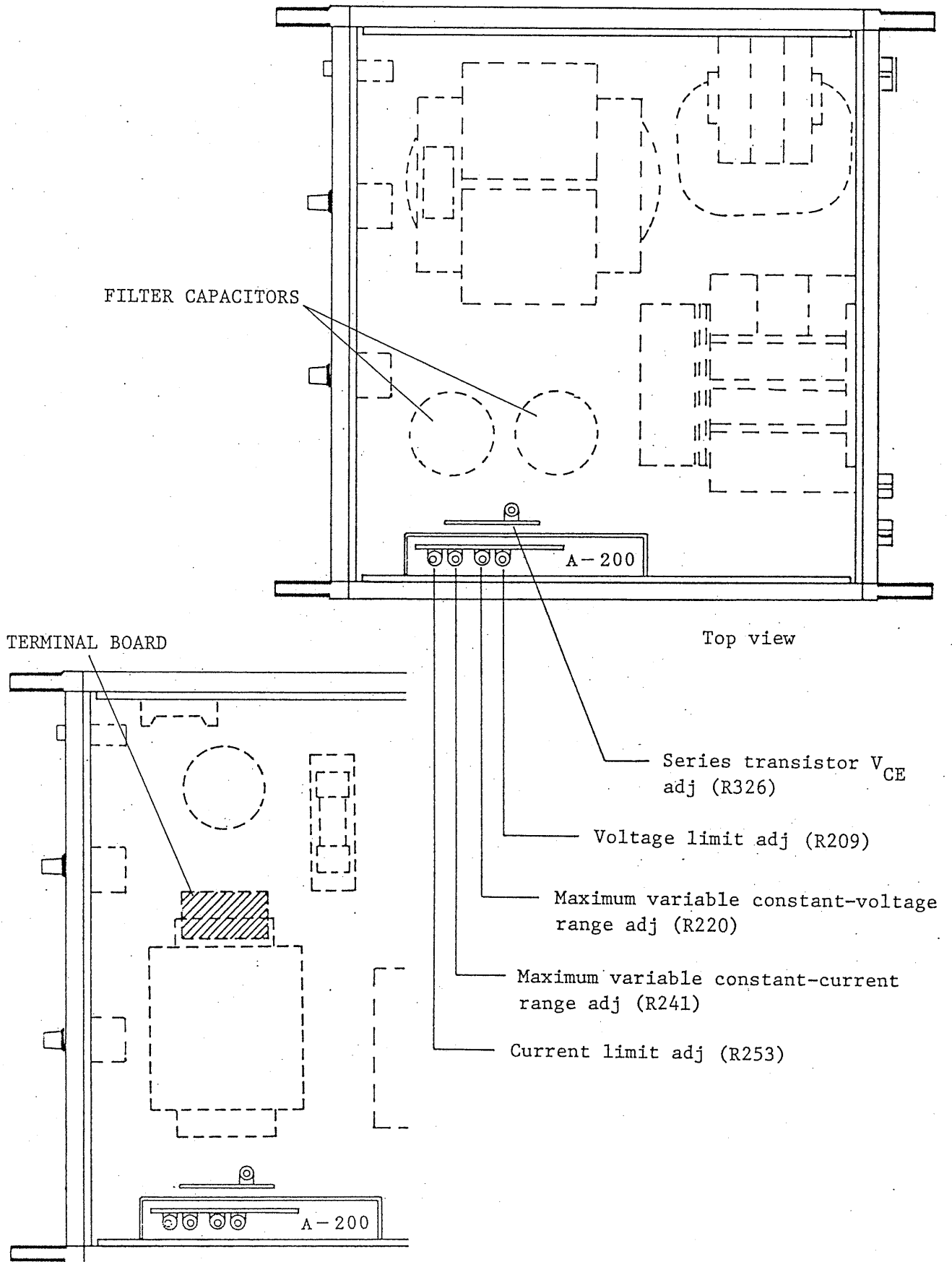

Model PAD8-50L

Figure 6-1

803612

6-2. Troubleshooting

The most probable causes of troubles are shown in the following table. When a failure of the power supply is found, contact Kikusui agent in your area.

Symptom	Check item	Probable cause
Power switch cannot be turned off (or turns off soon).	1. Has the overvoltage protector tripped?	o Set voltage too low
	2. Shorting bar disconnected?	o Disconnected or loose shorting-bar
	3. Is fan stalled?	o Trip of overheat protector (Replace fan.)
	4. Other than the above	o Trip of protector due to a failure of rectifier circuit
No output (No output is produced at all or only a slight output is produced.)	1. Is the input power fuse blown?	o Input line voltage too high (Replace fuse.) o Failure of rectifire circuit
	2. Is lamp lighted?	If not lighted, o Open-circuiting of power cord
	3. Are the lamps alternately lighting, indicating rapid transitions of operating domains	o Too narrow constant-voltage and constant-current setting ranges

8036/3A

Symptom	Check item	Probable cause
	4. Are the shorting-bars correctly connected?	o Wrong connection of shorting-bar(s)
	5. Is the output power fuse blown out?	o Output current flowed exceeding the rated value o Power transistor failure
	6. Is the circuit oscillating?	o Phase inversion caused by remote sensing circuit (Connect an electrolytic capacitor at the load end.) Refer to 4.1. o (Re-adjust)
	7. Is a current flowing despite no load?	If flowing, o Failure of the protective diode connected in parallel with the output (This diode may be damaged if such load as battery is connected in the reverse polarity.)
	8. Other than the above	o Circuit failure
Abnormally high output	1. Is the shorting-bar disconnected? (Between 3 and 4 .)	o Disconnected or loose shorting-bar o Malfunctioning OVP circuit

803614A

Symptom	Check item	Probable cause
	2. Output voltage (current) cannot be reduced	<ul style="list-style-type: none"> o Power transistor failure o Bleeder circuit failure
Unstable output	1. Is the shorting-bar(s) loose?	o Incorrect connection of the shorting-bar(s)
	2. Is the AC line voltage correct?	o AC line voltage not within the specified range
	3. Special type of load	o See 2-4.
	4. When matter of drift is critical	o Allow approximately 30 minutes of stabilization time.
	5. Other than the above	o Circuit failure
Large ripple voltage	1. Is the AC line voltage correct?	o Input voltage too low
	2. Are the sensing terminals securely connected to the output terminals?	o Securely connect the sensing terminals
	3. Is a strong source of magnetic or electric field present near the power supply? (Is there no nearby auto-transformer, power transformer, or an oscillating source?) (Especially when in the constant-current mode)	o Electromagnetic induction (Move the source of trouble. Strand the wires.)
	4. Other than the above	<ul style="list-style-type: none"> o Circuit failure o (Re-adjust)

2436/17A0